

Soft-Touch™ Sitter User Manual

Model# Series
77XXXXXX & 78XXXXXX
UMSTS06-22LIT



CAUTION: This product is NOT certified for use in a motor vehicle.



Includes:

- 1 Sitter with 5-point harness
- 2 Attachment straps

5 Ways To Use Your Special Tomato[®] Sitter

USE UNIVERSAL ATTACHMENT STRAPS TO SECURE SITTER IN THE BELOW APPLICATIONS



ON CHAIR



CATCHUP CHAIR



MOBILE BASE



FLOOR SITTER



IN PUSH CHAIRS

Intended Use

The Soft-Touch Sitters are a versatile portable seating system for children who require mild to moderate seating and positioning support due to a musculoskeletal system disorder. Special Tomato Sitters come with a 5-point chest harness and a 3-point pelvic harness and are created out of a propitiatory soft material and foam inner core that provide clinically accurate support and comfort. Sitters also have external attachment straps that allow the seats to be affixed to a number of seating support surfaces, thus making them “accessible” for children with disabilities and promoting social inclusion.

⚠ WARNING: PREVENT DEATH OR SERIOUS INJURY FROM FALLING OR SLIDING

- To improve safety we recommend that users should not be left unattended at any time while using Special Tomato equipment.
- Be sure that all adjustments are securely fastened before you put the user into the product.
- Always secure the 5-point harness after transferring the child into the seating system.
- To prevent tipping: Do not attempt to move the seating system over uneven surfaces. Use care when transferring children in and out of the seating system.
- Always secure child in the restraint
 - Never leave child unattended
 - Always keep child in view
 - Secure straps tightly
 - Always use seating system on a smooth level surface
- Always be sure to lock casters and/or parking brakes when stationary.

Sitter Harness Threading & Connections



For a video tutorial
visit [youtube.com/
SpecialTomato1](https://youtube.com/SpecialTomato1)

Harness Diagram

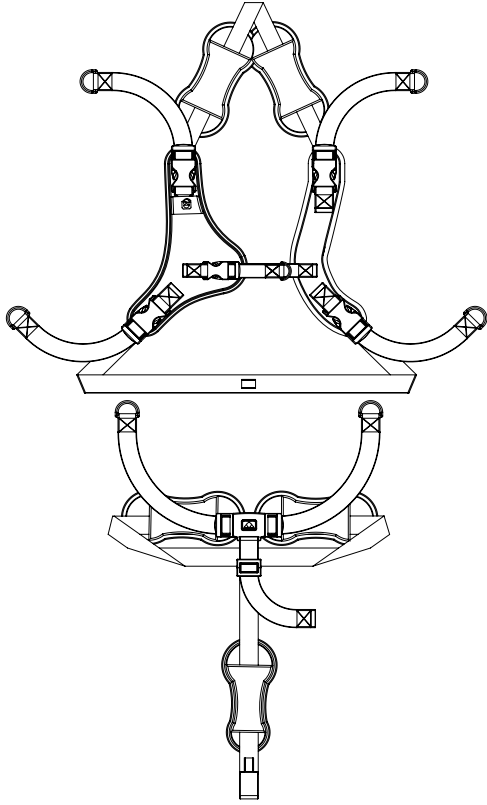

Harness Installed



**CHEST STRAPS
5-POINT HARNESS**

**3-POINT PELVIC HARNESS
WAIST & CROTCH STRAPS**

**ATTACHMENT STRAP
TO ATTACH TO A CHAIR, ETC.**

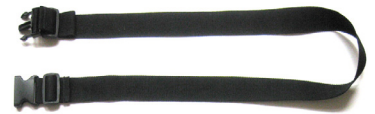

Pelvic Harness Installation



**STEP 1
CROTCH STRAP UP THROUGH
BOTTOM CENTER SLOT.**



**STEP 2
RIGHT WAIST STRAP UP
THROUGH RIGHT SLOT.**



**STEP 3
LEFT WAIST STRAP UP
THROUGH LEFT SLOT.**

Sitter Harness Threading & Connections (cont.)

Chest Harness Installation



STEP 1
UNCLIP RIGHT CHEST STRAP
AND SLIDE STRAP THROUGH
LEFT SHOULDER SLOT.



STEP 2
THREAD STRAPPING AROUND
THE BACK AND OUT THE
RIGHT SHOULDER SLOT.



STEP 3
CLIP TO THE TOP OF THE
RIGHT SHOULDER CHEST
HARNESS.



STEP 4
UNCLIP RIGHT LATERAL
STRAP AND SLIDE STRAP
THROUGH LEFT WAIST SLOT.



STEP 5
THREAD STRAPPING UNDER
THROUGH CROTCH LOOP AND
UP AND OUT THE RIGHT SLOT.



STEP 6
REATTACH THE CHEST CLIP TO
THE BOTTOM OF THE RIGHT
SIDE OF THE CHEST HARNESS.

Attachment Strap Installation



STEP 1
THREAD STRAP DOWN
THROUGH THE LEFT WAIST
SLOT.

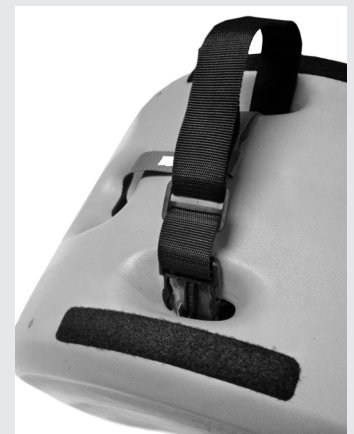

STEP 2
THREAD STRAP UNDER
SITTER ON TOP OF LOOP AND
UP RIGHT WAIST SLOT.

Sitter Harness Threading & Connections (cont.)

Attachment Straps & Applications

ATTACH TO A CHAIR

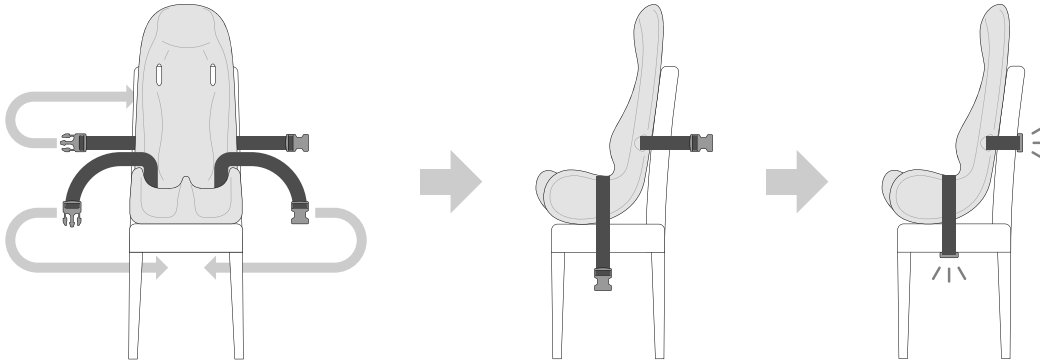

ATTACH TO A SPECIAL TOMATO® WOODEN BASE

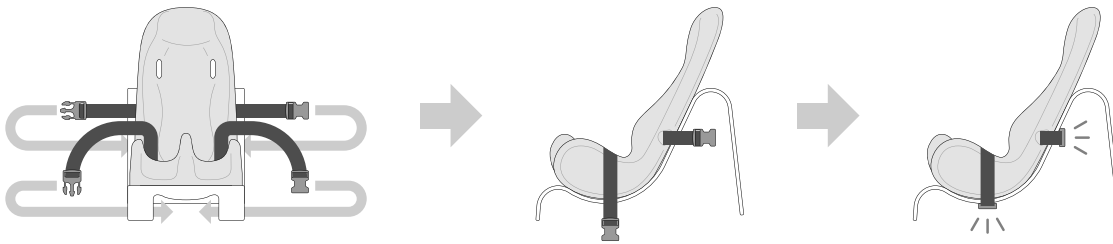

ATTACH TO A SPECIAL TOMATO® FLOOR BASE

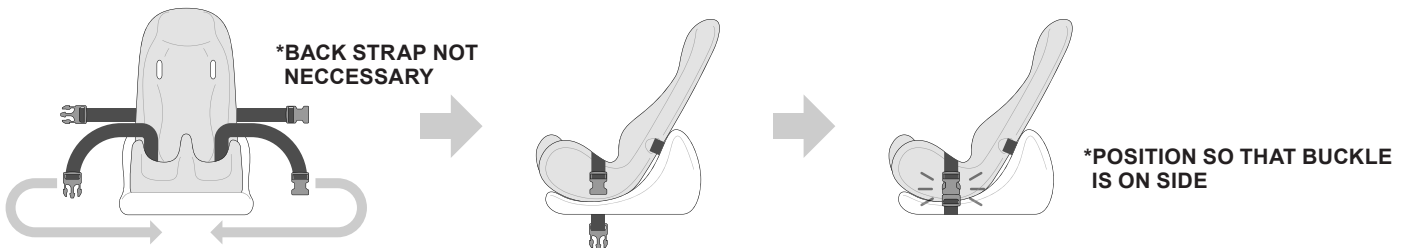

ATTACH TO A SPECIAL TOMATO® JOGGER, EIO OR PUSH CHAIR

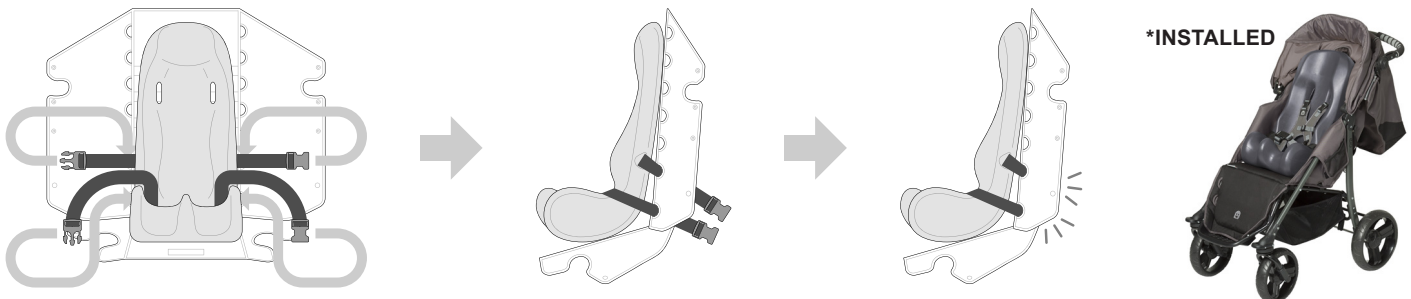

Sitter Harness Fitting

Proper Adjustment Techniques



USE THE SHOULDER COVERS TO PREVENT YOUR CHILD'S NECK AND FACE FROM RUBBING ON THE PLASTIC BUCKLES.

TO ENSURE PROPER PLACEMENT OF THE CHEST HARNESS ON YOUR CHILD, MAKE SURE THE CHEST STRAP LAYS IN THE MIDDLE OF THE CHEST (NIPPLE LEVEL).

THE PELVIC HARNESS HAS A CAM LOCK WHICH PREVENTS THE PELVIC BELT FROM LOOSENING TO MAINTAIN PROPER POSITIONING OF THE PELVIS.

THE PELVIC BELT HAS ONE QUICK-RELEASE BUTTON THAT UNLOCKS BOTH SIDES OF THE PELVIC HARNESS FOR QUICK AND EASY ACCESS TO YOUR CHILD.

ADJUST THE LENGTH OF THE CROTCH STRAP TO ALLOW THE PELVIC BELT TO LAY ACROSS THE PELVIS. THIS WILL PREVENT THE PELVIC BELT FROM LAYING ACROSS THE LOWER ABDOMEN.



THE PELVIC BELT HAS A CAM LOCK TO KEEP IT AT THE DESIRED LENGTH. FOR GROWTH ADJUSTMENTS, PUSH UP ON WEBBING TO RELEASE THE CAM LOCK.

25° Tilt Positioning

ALL BASES CAN TILT UP TO 25°



STEP 1
UNCLIP ATTACHMENT STRAPS.

STEP 2
ADJUST TO DESIRED ANGLE.

STEP 3
CLIP ATTACHMENT STRAPS TO SECURE.

Special Tomato® Customer Service

Phone: (315) 429-8407
Fax: (315) 429-8862
Email: info@bergeroncompanies.com
Website: www.specialtomato.com

5 YEAR LIMITED WARRANTY:

Special Tomato warrants to the original retail purchaser of the Soft-Touch Sitter product, that if any part or component proves defective in material or workmanship within five years of the purchase date, the defective part will be repaired or replaced (at Special Tomato's discretion) free of charge. Warranty service may be performed by an authorized service center or at Special Tomato's discretion.

- This warranty does not cover normal wear and tear, or damage caused by accident or misuse.
- To exercise this limited warranty, the user should first obtain a Return Authorization Number from Special Tomato.
- The product must be delivered with charges pre-paid (UPS recommended) to the factory or to an authorized service center, together with a copy of the original invoice, the Return Authorization Number and a written description of the problem.

SITTER CARE:

- Special Tomato Products are impermeable to fluids, but do not submerge. Use a mild detergent/cleaner to wipe the chair periodically.
- To extend the life of the hook and loop strips, comb out the hook portion (hard side) to remove lint and other debris.

HARNESS CARE:

- Place harness in a mesh bag and machine wash with cold water, then air dry. Harness pads can be removed, hand washed at 100°F (38°C). Air-dry only.

NOTICE:

Use only Special Tomato accessories and parts on Special Tomato products. Special Tomato parts are not interchangeable with other manufacturers' products. Replace any worn parts immediately for safety.



BERGERON HEALTH CARE

Bergeron Health Care
15 South Second Street
Dolgeville, New York 13329

T: 1-315-429-8407
F: 1-315-429-8862



Global Carehab
HOLMSTRUPGAARDVEJ 11
8220 BRABRAND
DENMARK
+45 24 65 55 50



© 2022 Bergeron Health Care

The information contained herein is subject to change without notice.