

dolphin  
MOBILITY

SEAMLESS  
MOVEMENT

FLOW X

ACCESS



Designed for seamless movement, the Flow X provides outstanding levels of comfort, confidence and craftsmanship.

Our most space-conscious stairlift, Flow X is designed to blend into your home effortlessly. Flow X is fitted onto your staircase and not your wall allow it to be installed quickly and efficiently, with minimum disruption to your home.

02

**A COMBINATION OF  
INNOVATION AND  
FUNCTIONALITY,  
FLOW X IS OUR  
MOST COMPLETE  
SINGLE RAIL  
CURVED STAIRLIFT**



03



Flow X carries me smoothly up and down the stairs and has taken a lot of hassle out of my life. It looks lovely in my home too. I would certainly recommend it!"

1

## COMFORT

The Flow X redefines premium comfort. It offers ergonomic and innovative features, all detailed with you in mind. The backrest and padded seat are specifically designed with a gentle recline which, combined with its height-adjustable seat and footrest, promote a natural, comfortable seating position, tailored to you.

Designed for effortless living, Flow X is available with complete automatic folding at the push of a button. This unique feature allows Flow X to do the work so that you can sit comfortably and enjoy its benefits from start to finish.

Experience the comfort of Flow X and choose from our collection of contemporary high-quality fabrics and finishes to make your lift truly part of your home.



2

## CONFIDENCE

The Flow X stairlift is designed and tested to the highest standards (Machinery Directive 2006/42/EC and EN 81-40), to give full confidence as you move around your home.

Flow X's innovative armrests provide several key benefits. They have an ergonomically-tapered form, designed to give you extra support both when standing and sitting. And thanks to the unique open-access armrest position, transferring to a stairlift has never been easier. Lastly, the smart detection device in the armrests prevents movement when the armrests are not in the correct position, providing full peace of mind.

During travel, Flow X's one-handed operation seatbelt and wrap-around armrests keep you secure throughout. And rest easy as the colour-coded indicator lights put you in control, so you always know that your lift is working correctly.

Flow X offers you an optional integrated call device feature (programmable up to three numbers), to ensure you can stay connected with friends and family when you're using the lift.

3

## CRAFTSMANSHIP

Flow X is our most complete curved stairlift. It has been designed to blend innovation with an inspiring contemporary design by Pearson Lloyd.

When you choose the craftsmanship of Flow X, you ensure a superior fit for you and your home. You receive a sleek, contemporary lift with options

tailored to you, with all mechanical elements elegantly kept out of sight. You benefit from our most compact lift, with our most generous, comfortable seating design. Enjoy a smooth and safe ride, as our ASL technology keeps Flow X perfectly level while it rotates during travel, ideal for staircases as narrow as 610mm.

Flow X is manufactured using the very latest technology and can be installed on any type of staircase. Our Advanced Swivel and Levelling technology (ASL) allows it to be fitted on staircases as narrow as 610mm. This feature, unique to Flow X, enables your stairlift to rotate while in motion, making it one of the most versatile stairlifts in the world.



**WHEN FLOW X IS  
FOLDED, ALL  
MECHANICAL  
ELEMENTS REMAIN  
ELEGANTLY OUT  
OF SIGHT**





08 **ASL**  
TECHNOLOGY

Our unique ASL technology enables the Flow X stairlift to rotate and stay perfectly level while in motion. By rotating during travel, you're always in the safest and most comfortable position.



1

The seat is always in the correct position to get on and off safely.

The Flow X swivels as it travels, this means that getting on and off the lift at either end of the staircase is quick and easy. At the top of the staircase, the seat can rotate away from the open staircase, allowing a safe exit from the seat.

2

Constantly working to save you time and provide safety and comfort.

ASL technology operates while the lift is moving. Therefore you avoid additional stops and swivel movements at the beginning, during and at the end of the ride. This saves time and provides additional safety and comfort. The lift really moves in one "Flow".

3

Internal or external rail on the narrowest and steepest stairs.

Even in cases where the staircase is narrow and steep, the Flow X can be installed closer to the step and on either side of the staircase. Your stairlift will be less obtrusive, and your staircase remains accessible for other family members in your home.

4

Unique technology that can only be found with Flow X.

Your well-being is important to us – when you choose ASL technology, the footrest swivels with the seat ensuring your legs and feet remain in a natural and comfortable position, relieving any additional strain on your joints.



12 **OPTIONS**  
IT'S ALL  
ABOUT YOU

When you choose the Flow X stairlift, you ensure the best fit for your home. With a single discreet rail, Flow X can be tailor-made to fit any staircase.

**RAIL**



**Standard Drop Nose**  
The standard drop nose is the perfect solution if there is an obstruction, such as a door near to the bottom of the stairs. The drop nose requires just 175mm of space from the bottom step.



**Vertical 'Short-Start' Drop Nose**  
Where space is even tighter at the bottom the 'short-start' drop nose can be installed, needing only 100mm of space from the bottom step.



**Horizontal Overrun**  
Where you have extra space at the bottom of the stairs, the horizontal overrun allows Flow X to be parked away from the bottom step.

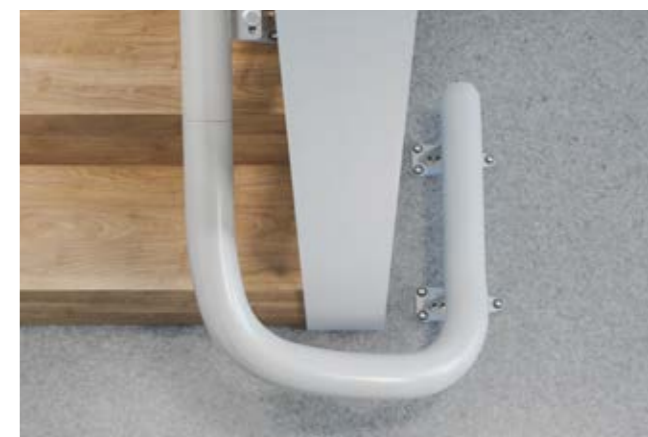

**Parking Curve**  
A parking curve allows Flow X to be parked neatly out of the way of the stairs.

**COLOUR**



Stone Grey  
RAL 7030

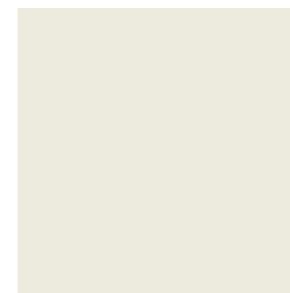

White  
RAL 9002



Pale Brown  
RAL 8025



Dark Brown  
RAL 8019

## UPHOLSTERY COLLECTION

### Vinyl



Natural Beige

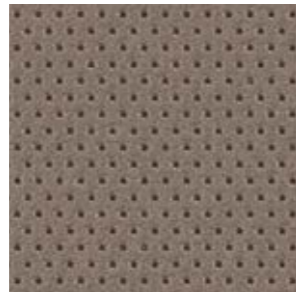

Basalt Grey

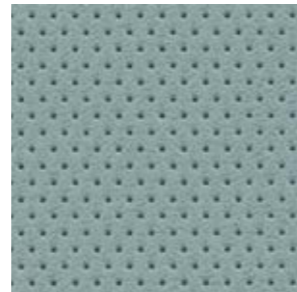

Pearl Blue

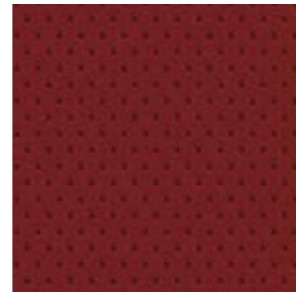

Deep Red

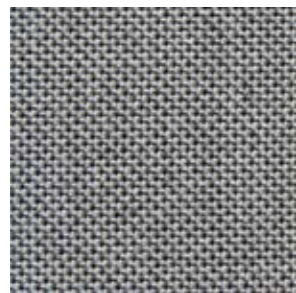

Mountain Grey

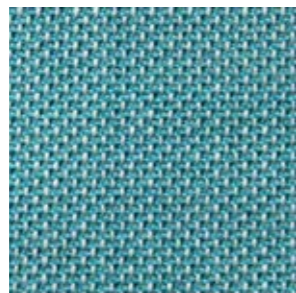

Mineral Blue

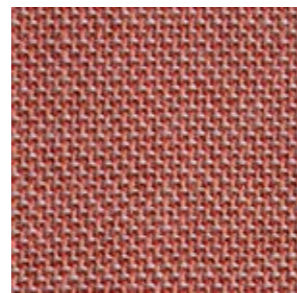

Coral Orange

14

### Leather



Firenze Smoke

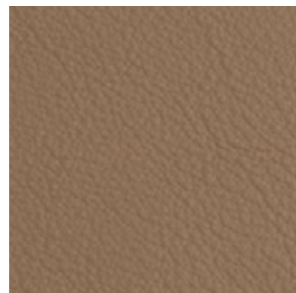

Firenze Tan

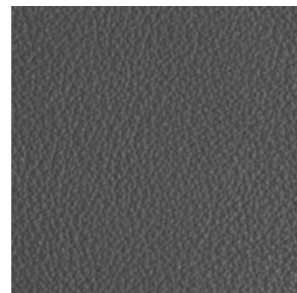

Firenze Grey

### Wood



Grey Oak

Our collection of high-quality fabrics and finishes allows Flow X to blend effortlessly into your home.

## ARMRESTS & SEATBELT



Straight



Curved



Open



Ergonomic Seatbelt

15

## JOYSTICK



With a comfortable soft-touch grip, the integrated joystick is designed for you to fold away neatly in the armrest when not in use.

## CALL DEVICE



Stay connected with friends and family with up to three different telephone numbers contactable directly from your stairlift.





16 **COMPLETE  
AUTOMATIC  
FOLDING**

Using a stairlift has never been easier with Flow X's complete automatic unfolding, at the push of a button. A unique feature only available with Flow X.

Choose between a fully automatic folding seat, automatic folding footrest or our innovative manual-folding version. The seamless movement of the manual folding is supported by an integrated gas spring that is discreetly hidden within the seat.



# CALL & PARK

## YOU'RE IN CONTROL

Intuitive remote control units at the top and bottom of the stairs are used to call your lift and to send it to a parking point when not in use. With a modern handheld design and a clear status indicator that mirrors the stairlift, calling and parking has never been more convenient.



**FLOW X BLENDS  
EFFORTLESSLY  
WITH YOUR DECOR  
AND FURNITURE**



# TECHNICAL SPECIFICATION

## CERTIFIED TO THE HIGHEST STANDARDS

### SPECIFICATION

Speed	Max 0.15 m/s
Drive Type	Rack and pinion
Motor Wattage	350 W
Weight Capacity	125 kg (275 lbs)
Automatic Stop	Yes
Staircase Incline	Up to 72°
Operation	Armrest detection and foldable joystick control as standard
Batteries	2 × 12V batteries, total 24V
Certification	Machinery Directive 2006/42/EC EN 81-40
Model Code	RP00-CU
Automatic Stop	Yes
Footrest	Available in 2 sizes Adjustable to 5 positions
Seat Height	Adjustable to 4 positions 515 - 585mm (floor to top of seat)

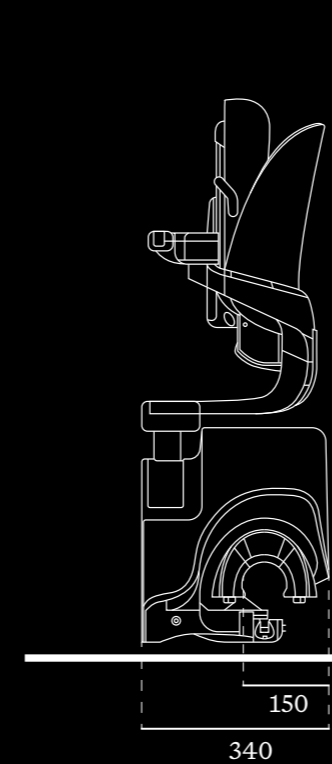
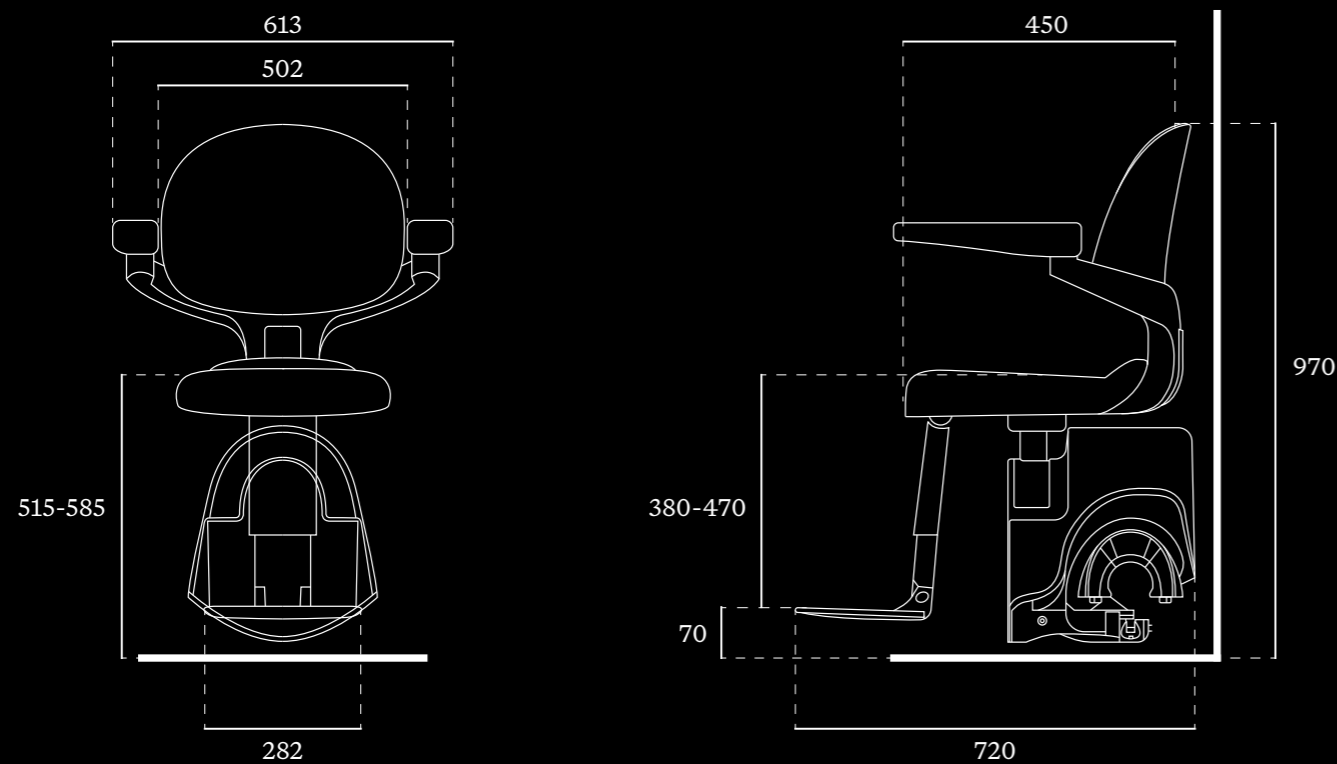

The Flow X stairlift is a game-changer. It's one of the most reliable and smartest products I've had the pleasure of working with."

**WITH FLOW X  
YOUR STAIRCASE  
REMAINS OPEN  
AND ACCESSIBLE  
FOR OTHER  
FAMILY MEMBERS  
IN YOUR HOME**

24

25



# ABOUT ACCESS



26

Access BDD is a division of TK Elevator. We give people around the world the ability to move comfortably around buildings by providing stairlifts, platform lifts and home lifts, which we distribute via a network of carefully chosen business partners. When you choose an Access BDD lift, you're choosing a high-quality product, supported by expert service and advice.

Our partners are all specialists in mobility or elevator products, and they receive extensive technical and commercial training on our products. Your Access BDD partner will guide you through the product options to help you choose a lift that meets your own needs and suits your surroundings. You'll also receive expert advice to ensure that your new lift conforms to relevant accessibility and safety regulations.

Our products are designed for easy installation and maintenance, with everything taken care of by your Access BDD approved partner.

27

**WE PROVIDE  
STAIRLIFTS,  
HOME LIFTS AND  
PLATFORM LIFT  
SOLUTIONS TO  
SELECTED PARTNERS  
AROUND THE WORLD**

Access BDD is one of Europe's leading suppliers of stairlifts, platform lifts and home lift solutions.



Scan to watch our Flow X customer journey video.

Your local Access BDD partner is:

