



WeGo

User Manual



Family Freedom

fireflyfriends.com



MANUFACTURED BY
IBELIEVE SPORTS LTD FOR
JAMES LECKEY DESIGN LTD

TEL: +44 (0)28 9260 0750
MODEL: WEGO PUSHCHAIR

MONTH AND YEAR
OF MANUFACTURE: 2018/11

IMPLEMENTATION
OF STANDARDS: ISO 7176

**REGISTERED TRADE NAME
AND ADDRESS**
JAMES LECKEY DESIGN LIMITED

19C BALLINDERRY ROAD, LISBURN
BT28 2SA, UNITED KINGDOM

TEL: +44 (0)28 9260 0750
MODEL: WEGO PUSHCHAIR

MONTH AND YEAR
OF MANUFACTURE: 11/2018

IMPLEMENTATION
OF STANDARDS: ISO 7176



WARNING: To avoid serious injury from falling or sliding out, always use the seat harness. Never leave child unattended. **IMPORTANT:** Keep these instructions for future reference. A child's safety is your responsibility. This push chair is suitable for one child. **WARNING:** This seat is not suitable for children under 6 months.

**MEETS THE BS 1021- PART1:
2014 SAFETY REGULATIONS
FOR CIGARETTE IGNITION**

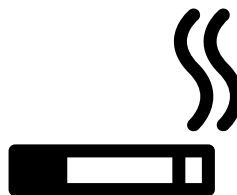

**CAUTION CARELESSNESS
CAUSES FIRE**

The Firefly WeGo is a lightweight pushchair that is fully foldable and allows for ease of travelling and daily activities.

CONTENTS

01 Intended Use	p.04
02 Certification	p.05
03 Warnings and Cautions	p.05
04 Terms of Warranty	p.07
05 Safety Information	p.08
06 Precaution and Contraindications	p.10
07 Cleaning & Care	p.11
08 Product Servicing	p.11
09 Important Guidelines	p.11
10 Product Inspection	p.12
11 Reissuing Firefly Products	p.13
12 Setting up your WeGo	p.14
13 Adjusting WeGo	p.20
14 Using the GoTo Seat with WeGo	p.22
15 Adjusting WeGo Harness	p.25
16 WeGo Dimensions	p.26
17 Table of Symbols	p.27

SECTION 01: INTENDED USE

Intended Use

The WeGo pushchair is intended to provide mobility for children who cannot walk independently up to a maximum weight of 30kg. It is also suitable for children that require additional upper body support and cannot sit-up unaided.

Indications for Use

WeGo is indicated for both prescriptive and non-prescriptive use for children who require mild levels of postural support or who have difficulties with ambulation.

WeGo is primarily a non-prescriptive device available directly to parents/ carers. Users may include, but are not limited to, non-ambulatory children with a neuromuscular, congenital, or chromosomal disorder, spinal cord injury or global developmental delay. These conditions typically affect the person's ability to sit unsupported.

WeGo is designed to be compatible with the GoTo Seat; a portable seating device manufactured by Leckey and designed to provide higher levels of short-term postural support to children with a disability. For children who require this higher level of postural support, WeGo indicates that it requires additional use of the GoTo Seat.



Warning – Child should be secured in the 5 point harness at all times and never left unattended whilst in the pushchair.

Warning – When your WeGo is stationary we recommend the brake be fully engaged to prevent any unintended movement.

WeGo is designed for short term use only and will not offer suitable long-term postural support for a child with additional needs. The device is indicated to promote inclusion within the community and to assist carer transportation.

Due to the intimacy of personal care associated with children, this product is designed such that skin and body fluids including urine and faeces may contact the device. All devices have been designed with this in mind and cleaning instructions are provided to ensure a child or adults health is uncompromised.

SECTION 02: CERTIFICATION

WeGo is classified as a Class I Medical Device under EU and UK regulations. As the manufacturer, James Leckey Design Limited, declares that this product conforms to the Medical Device Regulation (2017/745), UK Medical Device Regulations 2002, Medical Device Directive (93/42 EEC) and EN 12182:2012 Assistive products for persons with disability, general requirements and test methods.

Notice to the user and/or patient:
Any serious incident that has occurred in relation to the device should be reported to the manufacturer and the competent authority of the Member State in which the user and/or patient is established.

NOTE:

General user advice.

Not following these instructions may result in physical injury, damage to the product or damage to the environment!

SECTION 03: WARNINGS AND CAUTIONS

Warning Toppling Hazard:

- Never leave WeGo on uneven ground.
- Never leave the child unattended whilst seated in WeGo, for example, when they sleep.
- Always check that recline, GoTo Seat securing buckles, and canopy are secure before the user is transferred into the pushchair. Secure the 5-point harnesses or GoTo Seat 5-point harness as soon as the user is placed in the pushchair
- Ensure that the brake is fully engaged and secure (audible 'click').
- Avoid attaching heavy bags to the push handles.
- Check that the pram body or seat unit or car seat attachment devices are correctly engaged before use.

Warning Finger Trap Hazard:

- Take care that the fingers of the operator or child do not get trapped in the spaces between the seat and the frame.

Warning Occupant Security:

- WeGo is not suitable for children under 6 months.
 - Before placing the user in WeGo, adjust the product into its therapy orientation and check its stability and that the pushchair frame is fully locked out, and the park brake is fully engaged.
 - User transfers in and out of the product must be done with appropriate equipment and personnel.
 - Ensure there is adequate access space before making a transfer into the device and that all clips and buckles are secure (i.e., GoTo Seat securing buckles). Shifting the user while seated or any adjustments of seat whilst the user is seated is not advisable.
 - Ensure that all of the occupant 5-point harnesses are fastened and adjusted to hold the occupant securely in place before using WeGo. Never leave the child unattended whilst seated in WeGo. Strangulation or suffocation risk if users become trapped in parts of the pushchair.
 - If the user exhibits any form of distress, remove from the product as quickly as is safely possible.
 - To avoid injury, ensure that your child is kept away when unfolding and folding this product.
- Do not let your child play with this product.
 - This product is not suitable for running or skating.
 - Never use this pushchair for more than one child.

Caution Finger Pinch Hazard:

- Take care when assembling or adjusting the position of the seat components that the user or your fingers do not get pinched when positioning seat components and tightening mountings.
- The carer should not touch any moving joint or pivot that is not locked.
- Take care when assembling and unfolding and folding the pushchair frame that fingers do not get pinched, equally when adjusting the seatback recline.

Caution Daily Checks:

- WeGo is to be checked daily before use to ensure that all harnesses, seating and frame elements are securely attached.
- Always visually inspect the product before use. If in doubt, STOP. If you suspect or know the product or a part is faulty, STOP. Contact our customer services department or local dealer as soon as possible.

Caution Cleaning:

- Clean the product regularly to prevent the build-up of dirt. Accumulated dirt can prematurely wear the fabric components and encourage corrosion on the product. Only use non-abrasive household cleaners and moist cloths, do not use running water on the upholstery whilst it is still attached to the product. Always ensure the product is dry before use. See Cleaning & Care information of the user manual

Caution Cleaning Power Washers/ Hoses:

- Do not use hoses or power washers on the frame components, the frame is not sealed against running water and may be damaged by water ingress.

Caution Storage:

- The product should be kept away from all direct sources of heat, including naked flames, cigarettes, electric and gas heaters.

Caution Disposal:

- Only dispose of WeGo in a community waste disposal site under the correct recycling category.

This product is suitable for a child who cannot sit up unaided, roll over and cannot push themselves up on their hands and knees. Maximum weight of the child: 30kg

SECTION 04: TERMS OF WARRANTY

The warranty for WeGo applies only when the product is used according to its intended use, following all manufacturer's specifications.

A one year warranty is provided with this James Leckey Design Ltd. manufactured product.

Goods can be returned to us for warranty, repair or replacement up to 12 months from receipt. Once you contact us, we will arrange collection of the goods at our expense and, once returned to us we will repair or replace goods and return them to you within 14 days. In all cases, it is the customers' responsibility to ensure the goods being returned are suitably packaged, preferably in the original packaging.

SECTION 05: SAFETY INFORMATION

1. Always read user instructions fully before use.
 2. Always ensure you assess the WeGo for suitability before placing the child into it.
 3. Children should not be left unattended /unsupervised at any time in this product.
 4. The maximum user weight for WeGo is 30kgs (66lbs). This should never be exceeded.
 5. Do not modify WeGo or use components other than Firefly approved components with WeGo at any time. This may put your child at risk and also invalidate your warranty.
 6. The WeGo has not been crash tested so cannot be used for transportation in motor vehicles.
 7. This pushchair has been designed to carry one child. Do not carry additional items or children except as advised in this manual. Failure to comply may cause damage to the pushchair and/or make it unstable.
 8. Overloading or incorrect folding may cause damage to the pushchair.
 9. If you are using the GoTo Seat with WeGo, always ensure it is firmly secured to the pushchair by attaching the three black straps.
- Please go to section 14 for further guidance.**
10. Use extra caution when using the pushchair when your child is in full recline as it may increase the risk of tipping.
 11. Always lift the front wheels over curbs or steps by pushing down on the handle.
 12. The WeGo must be kept away from all direct sources of heat including naked flames, cigarettes, electric and gas heaters.
 13. This pushchair is not suitable for running or skating.
 14. Never allow children to fold, assemble or disassemble the pushchair.
 15. Never allow the pushchair to be used as a toy or allow children to give rides to others.
 16. If you are in any doubt about the safe use of this pushchair or if any parts should fail, please cease using the product immediately and contact Firefly Customer Services on **customer.enquiries@fireflyfriends.com**



Warning: Failure to follow these instructions may put you or the child at risk.

Warning: Keep the plastic cover away from children to avoid suffocation

- **For added safety**, it is recommended that the tether/ wrist strap is worn at all times to prevent the pushchair from rolling away.
- When stationary, the brake should be pressed firmly until an audible click is heard. This click indicates that the **brake is fully engaged**.
- Make sure to disengage the brake before moving off. The red bar should be returned to the original position to disengage the lock.
- Never leave your child unattended in the seat.
- Check that the pram body or seat unit or car seat attachment devices are correctly engaged before use.
- Make sure that the child is secured by the 5-point harness restraint system to stop them from falling out of the chair.
- Make sure that your child is not in close proximity when folding and unfolding the chair. This will help to avoid injury.

Warning:

1. Keep the seat unit away from any source of flame or ignition. This will stop any plastic or textile materials from becoming deformed or faulty
 2. Make sure that the child is less than the stated maximum user weight of 30kg to avoid damaging the seat.
 3. Never allow children to fold, assemble or disassemble the pushchair.
 4. Never allow the pushchair to be used as a toy or allow children to give rides to others.
 5. Never use the pushchair for more than one child.
 6. The WeGo has not been crash tested so cannot be used for transportation in motor vehicles.
 7. This pushchair is not suitable for running or skating.
 8. Keep the plastic cover away from children to avoid suffocation
 9. Overloading or incorrect folding may cause damage to the pushchair.
- Failure to follow these instructions may put you or the child at risk.**

SECTION 06: PRECAUTION AND CONTRAINDICATIONS

Precautions:

- Fixed spinal deformities such as scoliosis or kyphosis.
- Severe muscle contractures.
- Severe muscular or skeletal asymmetry including hip dislocation.
- Progressive and muscle wasting conditions.
- High risk or recent history of bone fractures.
- High risk of pressure related injury or open sores.
- Strong, uncontrolled movement patterns.
- Poorly controlled seizure activity.
- Children dependent on the use of percutaneous endoscopic gastrostomy.
- Medical instability including compromised respiratory or cardiovascular function.
- Dependant on 3rd party life-sustaining apparatus such as oxygen tanks.
- Significant learning disabilities and/or behavioural issues.

Contraindications:

- The child is less than 6 months old.

There are no further contraindications associated with the use of WeGo.

All precautions and contraindications are taken at the discretion of the prescribing clinician or parent. Leckey and Firefly recommends a trained and experienced clinician to be present during all initial assessment, set ups, configurations and reissues in order to minimise risk.

SECTION 07: CLEANING & CARE

1. The pushchair can be cleaned with cold water (30°) with mild detergent.
2. The lining is removeable and machine washable in cold water and mild detergent. Do not tumble dry.
3. Always allow the product to dry before folding and storing away.
4. Clean the frame with a damp cloth and mild detergent.
5. Do not use abrasive cleaners on the pushchair.

Tip:

One of the best water-based upholstery cleaners is very easy to make at home. Put one cup of warm (not hot) water into a mixing bowl and then add 1/4 cup of biodegradable dish washing soap. Beat with an electric mixer at medium speed until the liquid becomes a thick foam. This foam will remove built up dirt and most food or drink stains. Not only is this cleaner, simple to make and inexpensive, it is also nontoxic and environmentally-friendly.

SECTION 08: PRODUCT SERVICING

For all service related issues please refer to the firefly website www.fireflyfriends.com or contact the Firefly Customer Services team on customer.enquiries@fireflyfriends.com

SECTION 09: IMPORTANT GUIDELINES

1. Take care to avoid injury to fingers when unfolding and folding the frame.
2. Before placing the child in WeGo, ensure all locking devices are engaged.
3. Secure the child in the harness as soon as they are placed in the pushchair.

Placing of child into GoTo Seat

1. The GoTo Seat must be securely fastened in place for its intended use before placing a child into the seat.
2. Ensure the harness straps do not obstruct placement of child into

the GoTo Seat. Shoulder straps and side lateral support straps should be very slack.

3. Close centre buckle and adjust side lateral support straps to ensure child is secure in seat harness. The shoulder strap length should be adjusted to fit your child securely.
4. The groin strap length can be adjusted by accessing the adjustment fitting underneath the padded cover. In the GoTo Size 2 the location of the groin strap can be moved outwards to provide more room for your child as they grow.

Removal of child from GoTo Seat

1. Slacken shoulder straps and side lateral support straps.
2. Unlock central buckle using release button on harness.
3. Slide shoulder straps off child's shoulders and gently remove child's arms from harness.
4. Once legs are safely through, gently fit child's arms through shoulder straps – the shoulder straps should be very slack. Ensure shoulder strap pads are on child's shoulders.

SECTION 10: PRODUCT INSPECTION

We recommend that various checks of the equipment are carried out before each use to ensure the product is safe.

1. Check upholstery for signs of wear and tear.
2. Check all buckles are in full working order.
3. Check all folding elements are secure and operating correctly before each use.
4. Ensure that all locking devices are engaged before use.
5. Check the brakes are in full working order.
6. Do not use the pushchair if any part is damaged or missing.

SECTION 11: REISSUING FIREFLY PRODUCTS

Before re-issuing a product, it is recommended that it is disinfected using one of the following procedures:

Note: Always clean the product first to remove accumulated soiling prior to disinfecting/sanitising.

1. Where possible, we recommend the use of an automated “fogger” disinfection system that is used to completely cover the product surfaces with a disinfectant agent. The manufacturer’s instructions for the chosen system should be referred to prior to use and followed exactly.
2. Where an automated disinfection system is not available, all product surfaces should be wiped over with disinfectant surface wipes or liquid disinfectant on a soft cloth. Suitable products are 70% IPA, 70% Alcohol or diluted bleach. The manufacturer’s instructions for the chosen product should be followed. Product upholstery and fabrics should be cleaned thoroughly in accordance with section, Cleaning and Care Information, of this manual.

Ensure a copy of the user manual is supplied with the product. If in any doubt about the continued safe use of your Firefly by Leckey product or if any parts should fail, please cease using the product and contact our Firefly Customer Services team as soon as possible on:
customer.enquiries@fireflyfriends.com

SECTION 12: SETTING UP YOUR WEGO

1. Open the frame of the WeGo by pulling up the handlebar and placing your foot on the rear axle tube as indicated. **A**
2. Lift the handle **B** until you hear a click, this will indicate the frame is locked open. **C**
3. Ensure the safety locks are both engaged.
4. To collapse WeGo pull locking levers on both sides upwards. **D**

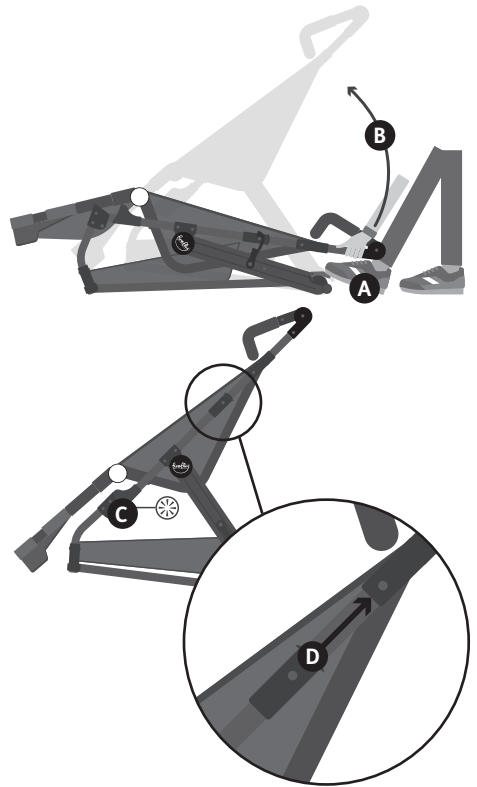

12.1 – REAR WHEEL ASSEMBLY

1. Lift the pushchair rear axle tube and insert the rear wheel axle until you hear a click, this will indicate the wheel is locked into position. Repeat for the second wheel.
2. Ensure the wheels are installed properly before using the WeGo. To inspect, pull the wheel to make sure it is locked into position.

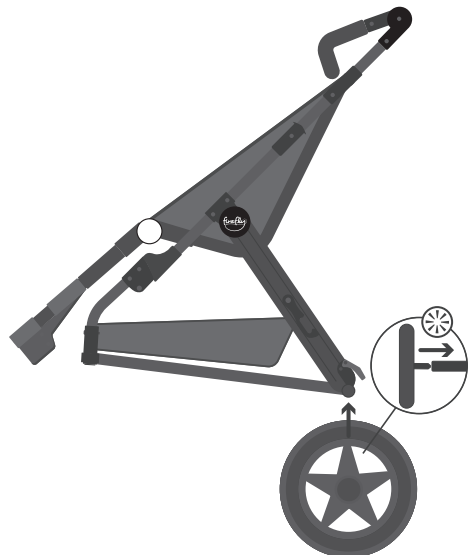

12.2 – FRONT WHEEL ASSEMBLY

1. Lift the pushchair front axle tube and insert the front wheel axle until you hear a click, this will indicate the wheel is locked into position. Repeat for the second wheel. **A**
2. Ensure the wheels are installed properly before using the WeGo. To inspect, pull the wheel to make sure it is locked into position.
3. To lock the front wheels into position, align them into a straight forward position and slide the front wheel lock guide down. **A**
4. To unlock the front wheels, slide the front wheel lock guide up.
5. You will hear an audible click which indicates that the brake is fully engaged.

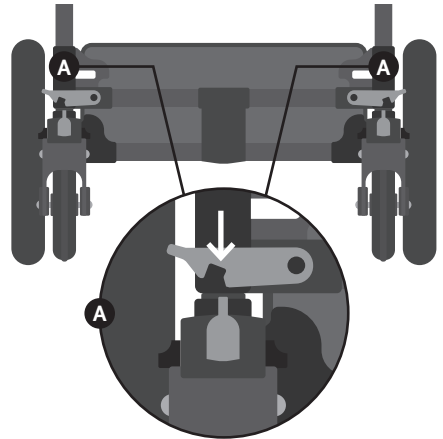

12.3 – ADJUSTING THE HANDLEBAR

1. To adjust the handlebar, press the black buttons on the inside of the handlebar assembly to adjust the handlebar to the preferred position. **A**

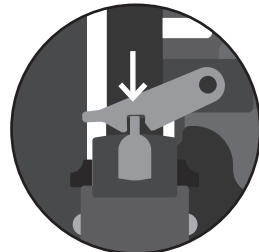
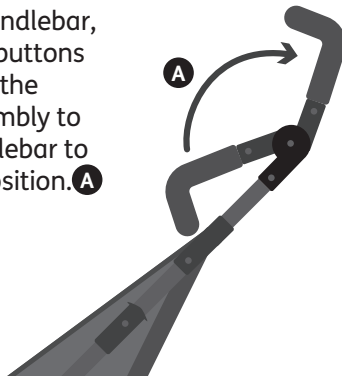

12.4 – USING THE BRAKE

1. To enable the brake press foot down on red brake bar until wheels are locked. You will hear an audible **click** which indicates that the brake is fully engaged.

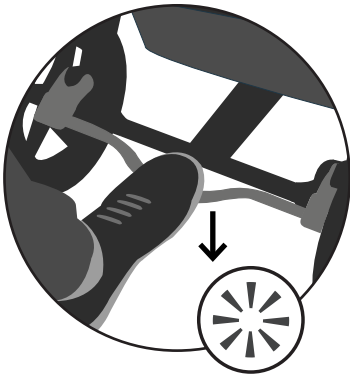

2. To release brake pull red brake bar back up to original position.

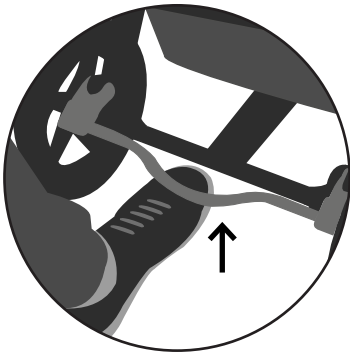

SECTION 12.5 – ATTACHING THE HOOD

1. Attach the plastic prong to the pushchair by sliding it into the attachment shown. **A**

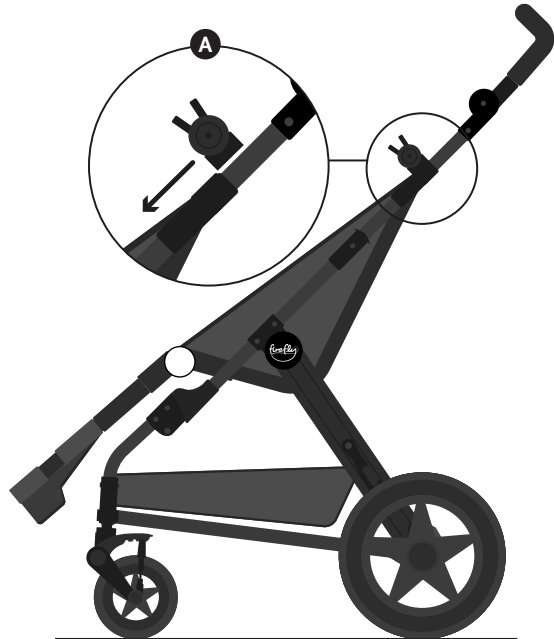

2. Feed the plastic rods through the material of the hood as shown in the image.

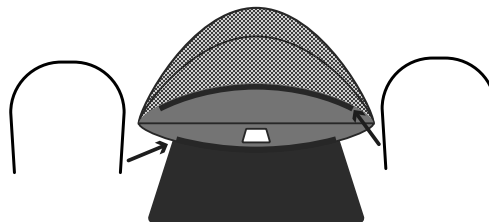

Continued →

3. Insert the rods into the plastic prongs on both sides of the pushchair and push down. **B**
4. Loop the black elastics around hooks on the back of the pushchair frame.
5. Connect the Velcro on the hood to ensure the hood is secure. **C**



SECTION 12.6 – ATTACHING THE RAIN COVER

1. Starting with the footrest, pull the rain cover over the pushchair and pull up over the hood and down the back of the WeGo.
2. Pull the wings down the side and secure inside the frame. **A**
3. Loop the black elastics around hooks on the back of the pushchair frame. **B**

Top tip – To put the backrest in a fully upright position, pull it forward and tighten as much as possible before attaching the hood

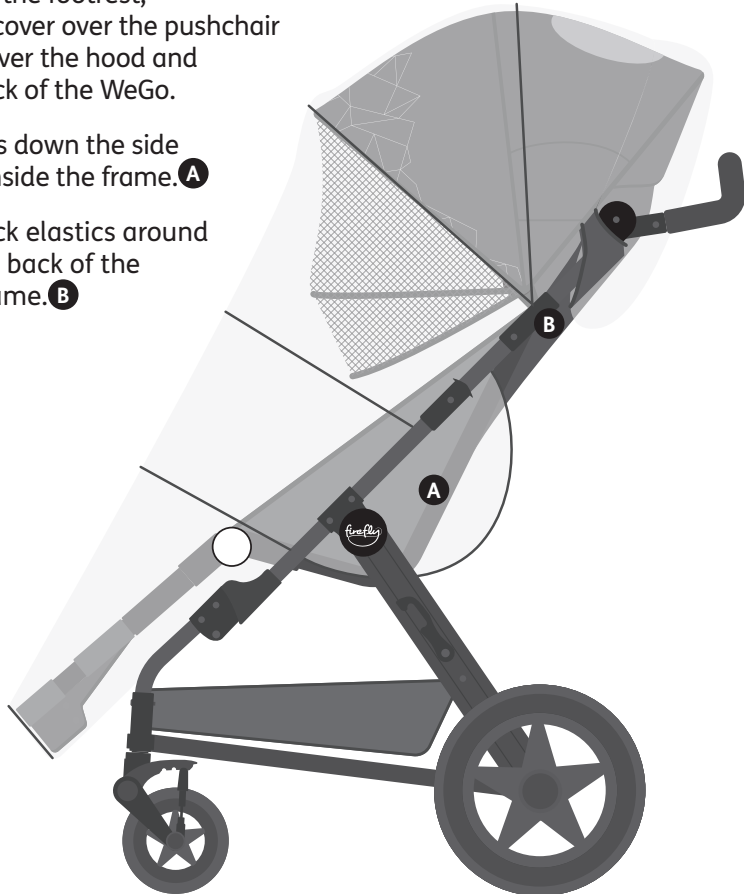

SECTION 12.7 – ATTACHING THE FOOTMUFF

1. Pull the footmuff over the footrest and feed the toggles through the loops on both sides of the pushchair. **A**



Children should not be left unattended / unsupervised at any time in this product.

Please ensure all footmuff adjustment parts are kept away from the child.

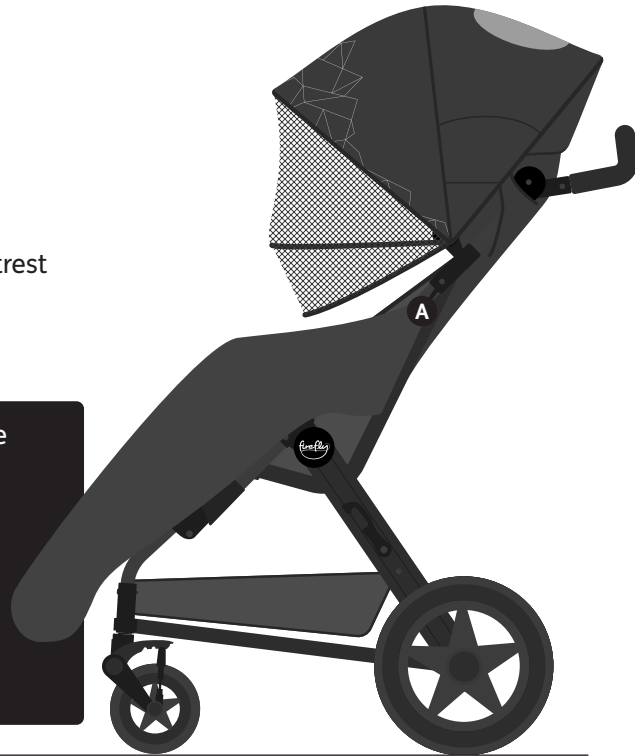

SECTION 12.8 – ATTACHING THE MOSQUITO NET

1. Place the mosquito net over the pushchair and attach using the toggles – feed the toggles through the loops on both sides of the pushchair.



Warning: Please only use cold drinks in the cup holder

SECTION 12.9 – ATTACHING THE CUP HOLDER

1. Slide the cup holder into the fixing on the right side of the pushchair frame.

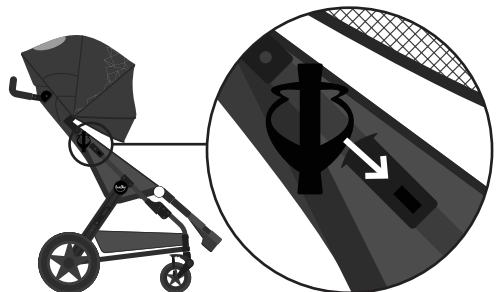

SECTION 13: ADJUSTING THE WEGO

13.1 – ADJUSTING THE BACKREST

1. To adjust the backrest backwards, pull the grey plastic lever toward yourself to your preferred angle. **A**
2. To adjust the backrest to an upright position, pull the grey plastic D – rings to your preferred angle. **B**
3. To get the seat in a fully upright position push the backrest up beyond the frame and tighten by pulling the plastic D-rings.

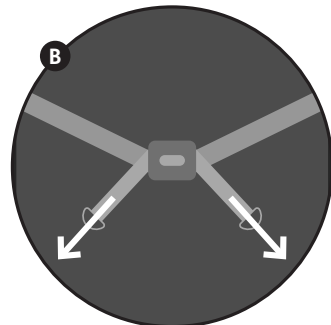
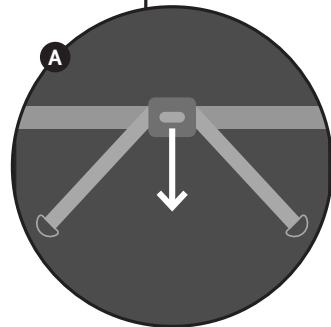
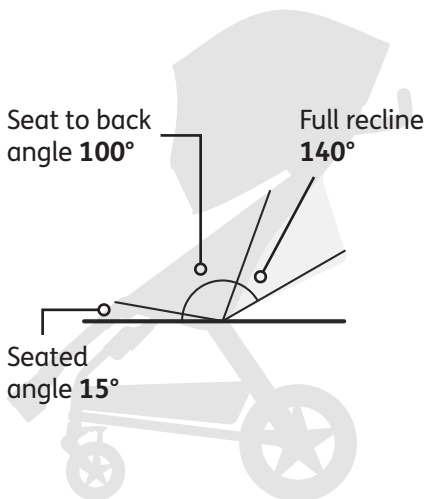

Warning – never attempt to adjust the WeGo when a child is occupying the seat

13.2 – ADJUSTING FOOTREST

1. To fix the footrest in the shortest setting, push up as far as it will go and secure the top popper on each side on the fabric. Please ensure they are fully engaged.

2. To fix the footrest in the longest setting, release the poppers and pull down until the locking pin has clicked and engage lower poppers on each side.

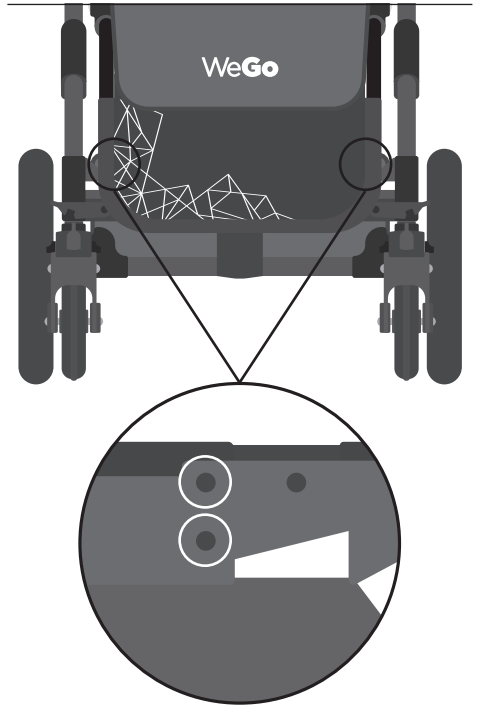
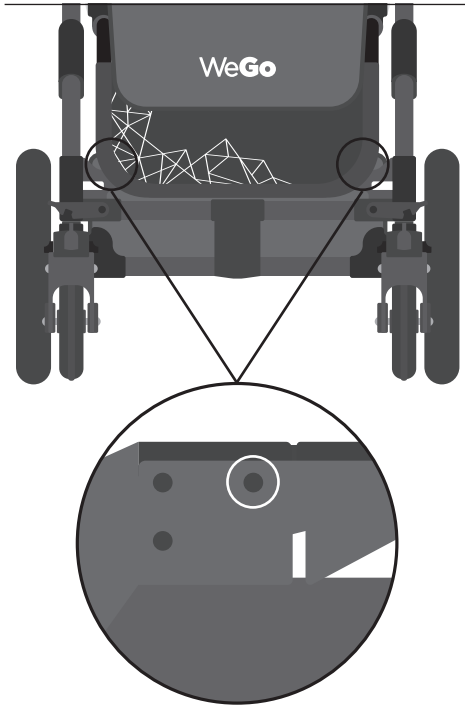

3. Footplate can be tilted to preferred angle by pressing the white button on the side hinge of the footplate.

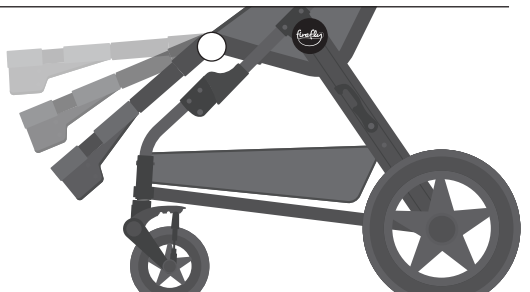

SECTION 14: USING THE GOTO SEAT WITH THE WEGO

1. Make sure all straps on the GoTo Seat are loose and not fastened to each other. Place the GoTo Seat into the pushchair.

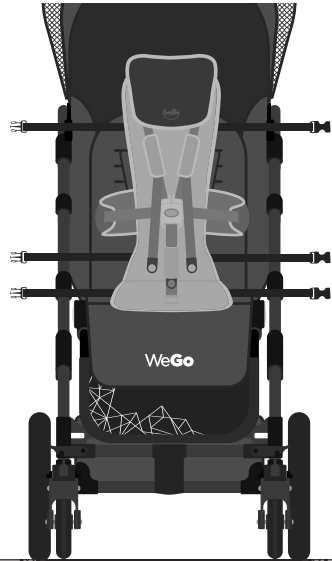

2. Feed the straps through the slots shown and fasten on both sides.

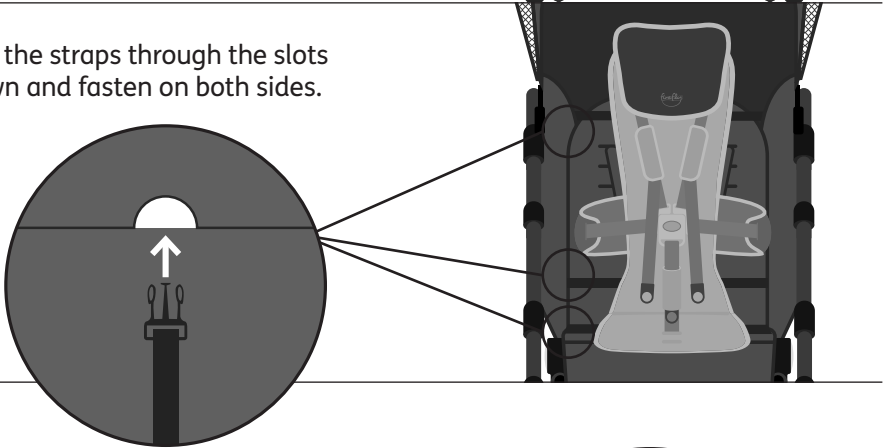

3. Pull straps outwards to tighten. **A**
4. Tidy excess straps into loops and secure into the clips. **B**
5. Ensure all black straps are securely fastened around the pushchair and the five – point buckle at the front is unfastened before placing the child in the GoTo Seat.

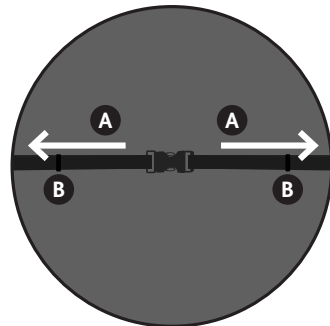



SECTION 14.1: OPENING & CLOSING THE 5 POINT BUCKLE

Before beginning, ensure shoulder, lateral support and groin straps are all loose and unfastened.

Attach the two lateral support fastenings to the sides of the mid-point buckle. **A**

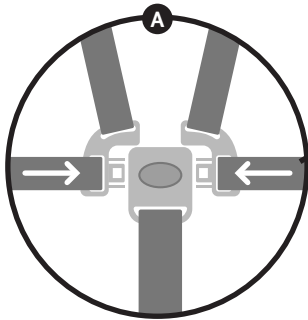
Once fastened, adjust the shoulder straps, lateral support straps and groin strap by pulling the straps to tighten. **B**



 **Make sure the straps are not twisted when the buckle is closed.**

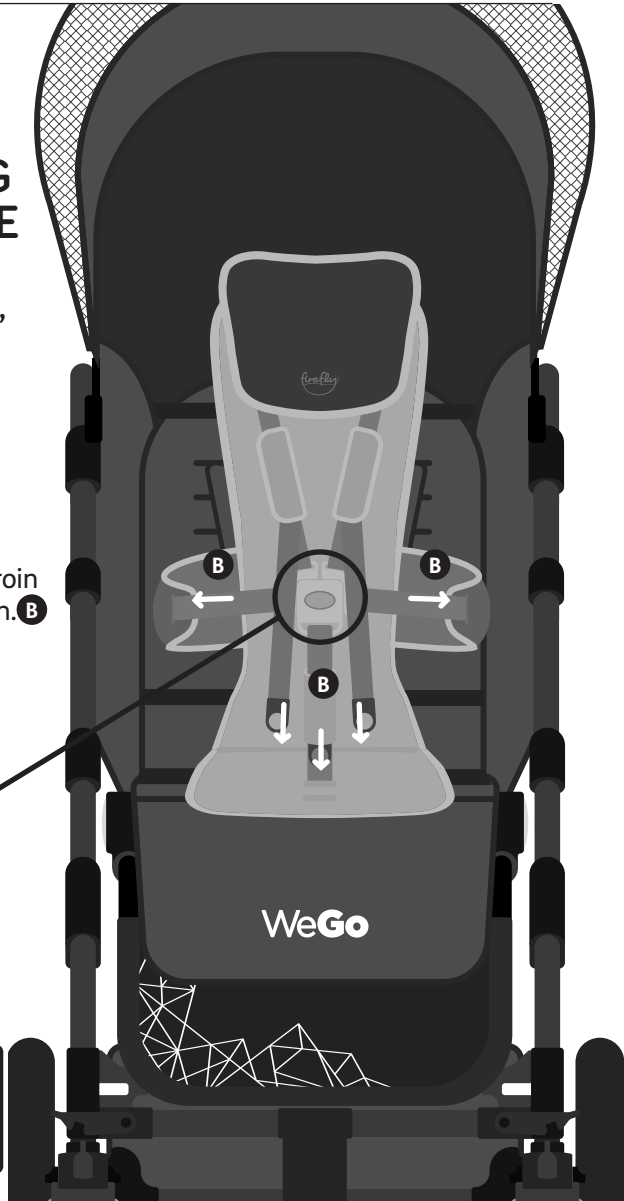

In Size 2 GoTo the groin strap mounting location can be moved backwards or forwards to suit your child's needs. Ensure it is firmly fitted to the plastic GoTo base. **C**

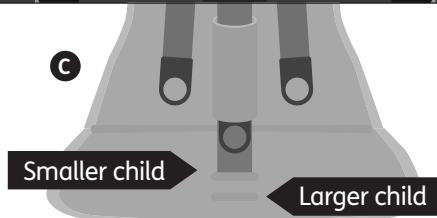

SECTION 14.2: ADJUSTING THE HEADREST AND LATERAL SUPPORT

Unscrew the knob at the headrest anti-clockwise to remove the headrest from the GoTo Seat base. Move the headrest up or down to achieve your desired position. **A**

Once you have the headrest at your desired height, screw the knob back in to the GoTo Seat base by turning clockwise. **B**

Detach the lateral support by turning the knob anti-clockwise. Move the lateral support up or down to achieve your desired position. Once you have the lateral at your desired height, secure the lateral again by turning the knob clockwise. **C**

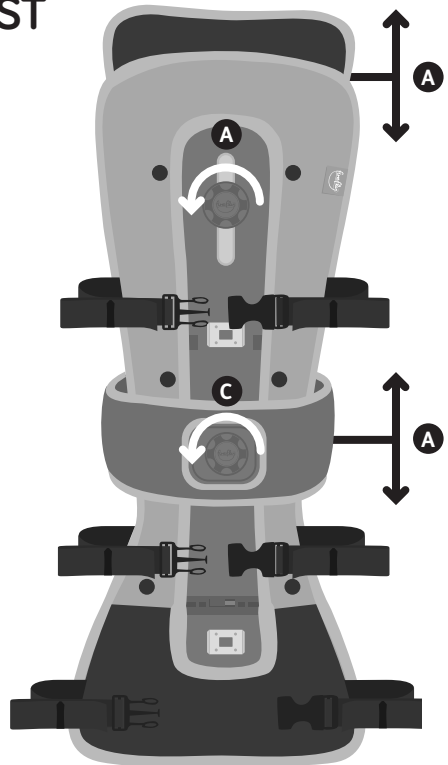

SECTION 15: ADJUSTING WEGO HARNESS

To adjust the shoulder straps on the WeGo, slide the end buckle on the back of the back rest through back slot. **A**

Then feed the buckle through the desired height slot. **B**

You can tighten or loosen up the straps by adjusting the buckles on the straps.

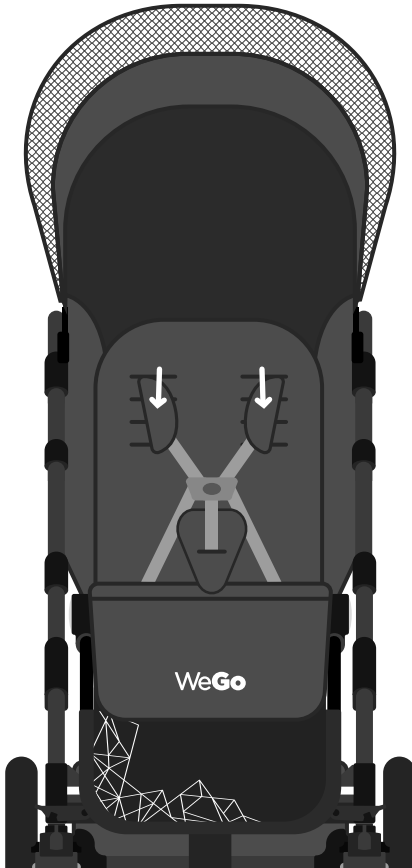
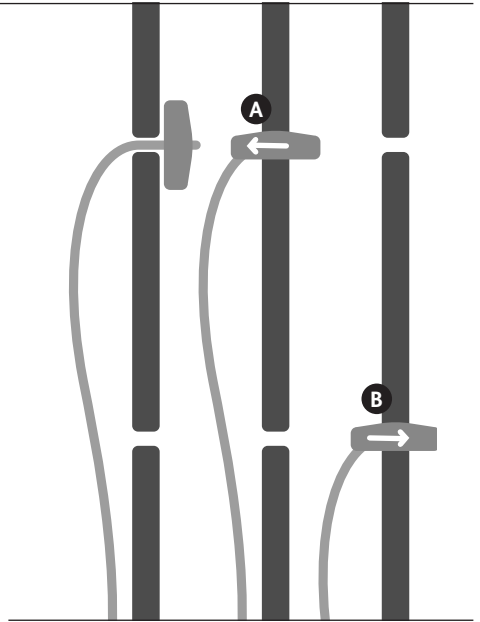







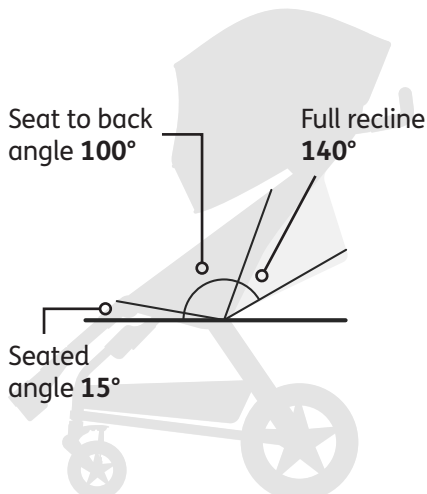





SECTION 16: WEGO DIMENSIONS

Footprint Length (Collapsed)	116cm
Footprint Height (Collapsed)	38cm
WeGo Height	122cm
Seat Depth	26cm
Seat Height	50cm
Seat Width	35cm
Footrest Shortest Length	25cm
Footrest Longest Length	33cm
WeGo Weight	11kg
WeGo Weight with GoTo Seat	13kg

Please note - Not all children using the GoTo Seat Size 2 will be suitable for the WeGo.
Please refer to our sizing guide.



SECTION 17: TABLE OF SYMBOLS

Symbol	Meaning
	Manufacturer
	Max Occupancy Weight
	Serial Number
	Product Code
	Read the Instructions for Use
	CE Mark
	Medical Device
	Warning
	Date of Manufacture
	Latex free
	Unique Device Identification
	UKCA Mark



Fireflyfriends Ltd
19c Ballinderry Road
Lisburn BT28 2SA
Northern Ireland

T: (+44) 28 9267 8879
E: hello@fireflyfriends.com

USA Distributor / Canadian Distributor

Fireflyfriends Ltd
19c Ballinderry Road
Lisburn BT28 2SA
Northern Ireland

T: 0044(0)28 9267 8879
E: hello@fireflyfriends.com

fireflyfriends.com

