



User manual

Coaster

Convaid
by Etac

UG2601-ENG-Rev.02 2023-11-03



www.etac.com

UK
CA



Customer Service Support

Toll Free: 1-844-US Mobility (844-876-6245)
Phone: (310) 618-0111
Fax: (310) 618-8811
US Email: convaidsales.us@etac.com
International Email: international.convoid.us@etac.com
US Website: www.etac.us.com
International Website: www.etac.com

Technical assistance or repair information hours are:
Monday-Friday, 6 a.m. to 4:30 p.m. PST

Before Calling:

Please fill in the following. Customer Service will be able to help you more quickly if the information indicated below is readily available.

Serial number of chair: _____

Model of chair: _____

Date purchased: _____

Notice: The information contained in this document is subject to change without notice.

No part of this document may be photocopied, reproduced, transmitted, transcribed, stored in a retrieval system or translated to another language or computer language, in any form or by any means, electronic, mechanical, magnetic, optical, chemical, manual or otherwise without the prior written consent of Convoid.

Use only Convoid accessories and parts on Convoid products. Convoid parts are not interchangeable with other manufacturers' products. Replace any worn parts immediately.

Table of Contents

General Information

Definition of Symbols	1
Intended Use/User	2
Suitable Environment	2
Transit	3
General Warnings.	4
Transit Model Warnings	6
Choose the Right Chair and Safety Options	8
Reuse	8

Product Overview

Coaster Product Line	9
Product Overview: Adjustable Fixed Tilt Coaster	10
Adjustable Fixed Tilt Coaster Specifications.	11
Product Overview: Adjustable Fixed Tilt Coaster Scout	12

Setting Up

Contents in the box	13
Preparing the Chair for Use	13
Unfolding the Chair	14
Folding the Chair	15
Lifting/Carrying the Chair	16
Fitting Guide	17
Seat Back Height	17
Seat Width	17
Seat Depth	17
Seat Depth Adjustment	18
Standard Two Piece Upholstery Position	19

Chair Set Up & Adjustment

Tilt and Recline.	20
Seat Angle (Tilt) Adjustment	21
Seat Back Angle (Recline) Adjustment	22
Adjustable Tension Back	23
Rear Anti-tip and Curb Tipper	23
Castor Locks.	24

Head Positioning Options

Headrest Extension	24
Occi Headwings	25
Padded Headwings	25

Trunk Positioning Options

H-Harness with Padded Covers	26
Full Torso Support Vest	26
Height and Tension Adjustable Back Positioner	27

Pelvic Positioning Options

Three-Point Positioning Belt	28
--	----

Foot and Leg Positioning Options

Lateral Thigh Support (Adductor)	29
Medial Thigh Support (Abductor)	29
Foot Positioners	30
Footplate Securement Strap	30
Footplate Height Adjustment	31
Additional Footplate Height Adjustment	32
Footplate Depth Adjustment	33
Angle Adjustable Footplate	33
Additional One Piece Foot Plate Height Adjustment	34
Calf Panel	34
Side Panels	35
Fixed Front Riggings to Elevating Leg Rest Adjustment	36

Coaster Scout Options

Attendant Hand Brake - Scout Only	37
Scout Hand Brake Pad Adjustment	37
Scout Hand Brake Pad Wear	38
Scout Hand Brake Pad Replacement	38
Scout Brake Tension Adjustment	39

Wheels

Quick Release Wheels	40
Wheel Installation	40
Loose Front Wheel Adjustment	41
Locking and Unlocking Wheel Lock	41

Accessories

Headrest Cover (Canopy) 42

Rain Cover 43

Mosquito Net Cover 44

Height Adjustable Locking Armrest 45

Upper Extremity Support Surface (Tray) 46

Saddle Bags 47

Underseat Storage Basket 47

Utility Bag 48

Maintenance, Operating and Safety Instructions

Waste Disposal 49

Spare Parts 49

Chair Maintenance 50

Maintenance Chart 50

Cleaning 51

Storage 52

Repairs 52

Safety Instructions 53

Upholstery Removal 54

Transport, Storage, and Disposal

Recommended Clear Zones in Vehicle 55

Providing Clear Space & Padding 55

Securing the Chair for Transport 56

Restraining the Chair Occupant 58

Using Postural Belts and Supports 60

Trays and Other Wheelchair Components 60

WTORS Manufacturers 60

Storage 60

Repairs 61

Authorized Service Dealer 61

Declaration of Conformity 61

Warranty

Warranty 62

Warranty Period 62











READ BEFORE USE





Read the user manual completely before use and fully understand its content. Familiarize yourself with the handling and functions of the product before use and practice them. Any caregiver that is going to operate this chair should also read the user manual in full.

You are responsible for the safety of the user. The safety of the user could be affected if you do not follow the instructions in this user manual. Nevertheless, not all possible circumstances and unpredictable situations can be covered by this user manual. Reason, care, and circumspection are not features of the product; they are required of persons who use the product. If instructions are not clear and further explanation is necessary, please contact your Convaid provider. If you do not follow all instructions and warnings, serious injury or damage to the chair may occur. The latest version of all instructions and product safety notices are available on the Etac website (www.etac.com) and can be printed in larger sizes. Additional video instructions are also available for reference purposes.

General Information

Definition of Symbols

	<p>Indicates the need for the user to consult the instructions for use for important cautionary information such as warnings and precautions that cannot, for a variety of reasons, be presented on the medical device itself.</p>		<p>This symbol is a mandatory marking for devices entering the European market to indicate conformity with the essential health and safety requirements set out in European Directives. The symbol may be accompanied by a four-digit identification number of the notified body. The vertical dimensions may not be less than 5 mm high.</p>
	<p>Indicates a medical device that need to be consulted with the instruction for user.</p>		<p>Indicates the Authorized representative in the European Community.</p>
	<p>This symbol indicates potential finger entrapment.</p>		<p>This symbol indicates the manufacturer's catalogue number so that the medical device can be identified.</p>
	<p>This symbol indicates correct lifting points for safe moving and handling.</p>		<p>Indicates the medical device manufacturer.</p>
	<p>This symbol indicates maximum user's weight.</p>		<p>Indicates the date when the medical device was manufactured.</p>
	<p>Indicates the manufacturer's serial number so that a specific medical device can be identified.</p>		

	<p>This symbol indicates a wheelchair which cannot be used in motor vehicle as vehicle seat. This wheelchair does not comply with WC19 (RESNAWC-4:2012 for ISO7176-19:2008) and cannot be used as a vehicle seat to transport the user in a vehicle.</p>
	<p>The symbol indicates a wheelchair which can be used in motor vehicle as vehicle seat. This wheelchair complies with WC19 (RESNAWC-4:2012 and ISO 7176-19:2008) and can be used as a vehicle seat to transport the user in a vehicle.</p>
	<p>This symbol indicates the position of an anchor point when using a 4-point tie down system (WTORS) during transit.</p>
	<p>This symbol indicates conformity with RESNA WC-4 Section 19 requirements.</p>

Intended Use/User

This product is intended for use by a person with physical disabilities who is occasionally or permanently non-ambulatory. This device is intended to assist a disabled person in performing an activity that the person would otherwise find difficult to do or be unable to do such as said person from one place to another while sitting. The chair is intended to always be under the control and supervision of an attendant, and the occupant should never be left unattended.

Suitable Environment

The chair is intended for both indoor and outdoor use. If the chair is used in the rain, the excess water should be wiped off with a soft cloth. If the chair is splashed with mud or corrosive substances like salt water or road salt, the chair should be washed clean with water, wiped dry and a hypoallergenic and biodegradable lubricant reapplied to the moving parts. Contact with seawater should be avoided, as it will corrode areas that cannot be washed clean. When going from outside to inside, clean any excess dirt or mud from the wheels to prevent soiling of inside environment.



WARNING: Do not leave/store the chair in direct sun/heat over a long period of time. Check the temperature of the chair prior to usage.

Corrosive substance such as salt water should be avoided at all times. If exposed the frame should be wiped off with a moist towel as soon as possible. Water and a soft cloth are sufficient for basic cleaning.

Transit

The optional transport models conform to RESNA WC19 or ISO 7176-19 standards. To be WC19 compliant, the Coaster Without Seating option must be functionally paired with cushions that meet WC-20 crash testing requirements. Dummy weights are:

Model CTR12T	66 lbs/30kg
Model CTR14T	100 lbs/45kg
Model CTR16T	170 lbs/77kg
Model CTR18T	170 lbs/77kg

Lateral Stability and Belt Restraint Accommodations Ratings

Chair Model	Mass (Weight) of Chair (lbs./kg)	Test Rating	Lateral Stability** (in/mm)
CTR12T	27 / 12.2	Meets all performance criteria	0.35 / 8.9
CTR14T	28 / 12.7	Meets all performance criteria	1.18/ 29.9
CTR16T	32 / 14.5	Meets all performance criteria	1.97 / 50
CTR18T	30 / 13.6	Meets all performance criteria	1.57 / 39.9

** “Lateral stability” is the displacement of point P (the center of gravity on the loaded wheelchair) when a platform with the loaded wheelchair is tilted 45° laterally from the horizontal. Higher numbers indicate less stability.

This table refers to tests performed in accordance with WC19/7176-19 to establish lateral stability during normal travel and the ease of use and proper fit of vehicle-anchored belt restraints. The letter designation reflects the overall rating of the lap and shoulder belt positioning and installation.

General Warnings



WARNING: The operator/caregiver must read and understand this manual prior to operating this equipment. If you are unable to understand any part of the manual, contact your supplier for assistance.



WARNING: Please keep packaging material away from children. Plastic packaging presents the danger of suffocation.



WARNING: The chair is only intended to carry one user at a time. Do not carry more than one user at a time.



WARNING: The weight carried by the Coaster chair must never exceed the total weight capacity of the chair. (Maximum occupant size plus any items carried.) When using the chair in transit, all accessories must be removed from the chair and secured separately.



WARNING: If the user's weight is less than 50 lbs, the use of anti-tip tubes is encouraged.



WARNING: To avoid tipping, do not hang item from the push handle.



WARNING: To reduce the risk of an accident:

- ALWAYS carefully read the user manual and get comfortable operating the chair.
- ALWAYS watch for obstacles and avoid them as often as possible.
- MAKE SURE that the chair operates properly. Repair any problems before use.
- ALWAYS verify that the quick release axles are locked so that the back wheels do not come off
- ALWAYS secure the user into the chair during use.



WARNING: Pay particular attention when on slopes and inclines to prevent:

- The user from falling out of the chair.
- The chair from tipping over.
- The chair from rolling away.



WARNING: Do not go up or down stairs without the assistance of another person or with user in the chair. If devices such as ramps or elevators are available, please use them. If they are not available, then the chair should be carried over the obstacle by two people without the user in the chair.



WARNING: Always secure user with belt first, before making any other adjustments.



WARNING: Before removing the user from the chair and before returning the user to it, always engage the wheel locks. Never remove or place user without engaging the wheel locks.



WARNING: Never leave the user unattended in the chair even when they are strapped in and the wheel locks are engaged.



WARNING: Do not stand on the foot support when getting into or out of the chair.



WARNING: When the user reaches for objects in front, to the side, or behind the chair, be sure that they do not lean out of the chair too far since the shift in the center of gravity might cause the chair to tilt or tip over.



WARNING: Positioning belts should never be used as a safety restraint device in a motor vehicle when transporting chair with occupant. An additional WC19 (ISO 7176-19) compliant automotive type seat belt is required when the chair is used in transport vehicles.



WARNING: Do not use the chair with pneumatic wheels unless it has proper tire pressure.(Front 36 psi/ Rear 30 psi, 248kPa/200kPa, 2.5BAR/2.0BAR) Do not over inflate the tires. Failure to follow these instructions may cause the tire to explode and cause harm. Tire size and maximum pressure are listed on the wheel.



WARNING: Ensure the wheels are installed properly. You will hear a “click” when wheel locks into place.



WARNING: Do not leave/store the chair in direct sun/heat over a long period of time. Check the temperature of the chair prior to usage.



WARNING: Coaster 18 exceeds the maximum recommendation width. Use caution when entering/ exiting small space.



WARNING: Coaster upholstery flame-resistant characteristics are not applicable when using aftermarket seating or cushions.



WARNING: For occupant safety, the seat belt should be used at all times.

- Do not leave user unattended.
- Do not strap user too tight.
- Straps should not interfere with breathing or circulation.
- Always apply wheel locks before letting go of the chair.
- If front edge of seat is at or forward of the point where tires touch the floor, avoid using front of seat tubes for support during entry or exit from chair to prevent tipping.
- Avoid using footplates for weight support during exit or entry of the chair.

Transit Model Warnings



WARNING: To reduce possibility of injury, the headrest extension must always be used with the chair in transit. The following instructions must be followed to minimize impact in case of a crash:

1. During transit, the chair must be forward facing with tray and storage basket removed.
2. Use only a tested, proven and compatible 4-point chair tie-down system (WTORS), and a 3-point occupant restraint system in accordance with SAE J2249.
3. The chair tie-downs must be securely attached to the four red anchor points on the chair. See arrows in above photo for anchor points.
4. The occupant restraints must include a lap and a shoulder bet, secured directly to the Coaster frame and side of roof of vehicle.
5. All floor tie-down straps must be drawn tight in the front and the back to eliminate any forward/back movement of the chair.
6. Chair restraint manufacturers' instructions must be followed precisely to ensure intended performance.

Note: Tray, storage basket and other accessories must be removed during transport in bus or van, except when medically necessary.

Note: Do not over tighten. This may cause damage to the frame.

The OPTIONAL Transit Version Coaster can transport users in motor vehicles that are compatible with Occupant Restraint Systems (WTORS). The chair MUST be secured in a forward-facing position with a Wheelchair Tie-down and Occupant Restraint Systems (WTORS), which meets the requirements of WC-4 or ISO 7176:



WARNING: The chair must be used as indicated in the user manual instructions accompanying the chair. Failure to do so increases the likelihood of serious injury in a vehicle crash.



WARNING: Do not attach tie downs anywhere except designated tie down locations.



WARNING: During transit, chair must be forward facing with the seating module in the forward-facing position on the mobility base. All accessories should be removed.



WARNING: Do not alter or substitute any part or component of the chair, chair frame or chair seating system.



WARNING: Coaster was dynamically crash tested in a forward-facing configuration using an appropriately sized crash-test dummy restrained by both upper-torso (shoulder) and lower-torso (lap) belts. To reduce the possibility of head and chest injuries resulting from contact with vehicle components, you must use both upper and lower torso belts.



WARNING: Both pelvic and torso restraint belts must be used while traveling aboard a motor vehicle.



WARNING: Do not attach tie downs anywhere except designated tie down locations.



WARNING: When riding aboard a motor vehicle, it is preferred that the chair user transfer into the vehicle's manufacturer's seat and use a federally approved, crash-tested seat.



WARNING: Whenever not medically necessary, auxiliary chair equipment should be removed from the wheelchair and secured in the vehicle during transit so that it does not break free and cause injury to vehicle occupants during a crash.



WARNING: Do not use the chair if it has been involved in a crash. In the event that your Coaster is involved in a crash, please contact the Convoid Service Dealer or Convoid Customer Service Representative in order to arrange an evaluation of your Coaster. For information on how to contact your representative please see page 62.



WARNING: Adequate clear zones are required for occupants restrained by both upper-and lower-torso belt restraints.

Choose The Right Chair & Safety Options

There are several options available to meet the needs of the chair user. Make sure that your (and your health care provider's) choice of chair and other added options takes into account the user's comfort, positioning, physical limitations, and hazards that may be encountered during daily use.

Operating the chair outside of the recommendations provided by the manufacturer can lead to a dangerous situation.



WARNING: The chair is not suitable for jogging, running, skating or similar activities. Swiveling front wheels tend to wobble at higher speeds and can cause a sudden stop, and the chair can tip over. Use the chair only at regular walking speed. Under no circumstance should you let go of the push handle while pushing.

The durability of this product is five years when it is used with proper care and maintenance according to the user manual.

Final selection of the type of device and any accessories or adjustments rests solely with the user and their health care provider. Some important factors to consider when choosing a configuration include, but are not limited to:

1. The user's disability, strength, balance, coordination, and ability limitations.
2. Neurological and orthopedic needs of the user.
3. Behavioral factors such as maturity and psychosocial development.
4. All factors should be considered when choosing a chair configuration as this can affect performance and function of the chair.

Reuse

Your Convaid chair should undergo wipe-down disinfection before re-use. Please use a non-toxic, biodegradable disinfectant solution suitable for surface disinfection. Please check the following components for completeness before operation (see MAINTENANCE CHART)

Repair or replace if necessary:

- Wheels (tread pattern), air pressure if applicable
- Frame
- Seat and back upholstery
- Wheel lock operation
- Bearings and axles: check wear and tear/need for lubrication
- Straight-running stability of wheels attachments

Product Overview

Coaster Product Line



Coaster 10° Seat Angle with Back Recline



Coaster 20° Seat Angle with Back Recline



Coaster 30° Seat Angle with Back Recline

Product Overview: Adjustable Fixed-Tilt Coaster

One piece height adjustable push handle

Chair warning label

Never leave occupant unattended. Failure to read and follow user manual instructions could result in serious injury. To obtain a replacement user manual email sales.us@convoid.com or call 844-876-6245.

Transit anchors*
(Option)

Transit anchor logo sticker



Foot operated wheel lock

11.5" x 2.5" Rear solid quick release tires

80° Front rigging

7.5" x 2" Front solid tires

Height adjustable swing-away footplates



Packaging label
(reference)



















Serial number label



ANVISA Label
(Brazil Only)

*Not shown - Headrest Extension, 3-pt belt, and torso harness required

Specifications

Coaster measurements		Coaster 12	Coaster 14	Coaster 16	Coaster 18
	Seat width	12" / 305mm	14" / 356mm	16" / 406mm	18" / 457mm
	Seat depth	10-12" / 254-305mm	11-13" / 279-330mm	12-15" / 305-381mm	14.5-17.5" / 368-445mm
	Seat back height (10° / 20° / 30°)	22"/23"/24" 559/584/610mm	25"/26"/27" 635/660/686mm	26"/27"/28" 660/686/711mm	28"/28"/29" 711/711/737mm
	Seat to footplate	6-16" / 152-406mm	6-16" / 152-406mm	6-20" / 152-508mm	6-20" / 152-508mm
	Seat to floor (10° / 20° / 30°)	19"/20"/21" 483/508/533mm	19"/20"/21" 483/508/533mm	21"/22"/23" 533/559/584mm	21"/22"/23" 533/559/584mm
	Overall height	40" / 1016mm	41" / 1041mm	42" / 1067mm	44" / 1118mm
	Overall length	30" / 762mm	31" / 787mm	32" / 813mm	33" / 838mm
	Overall width	22" / 559mm	24" / 610mm	26" / 660mm	28" / 711mm
	Folded height	17" / 432mm	17" / 432mm	17" / 432mm	17" / 432mm
	Folded length	32" / 813mm	32" / 813mm	35" / 889mm	35" / 889mm
	Folded width	22" / 559mm	24" / 610mm	26" / 660mm	28" / 711mm
	Headrest extension height	8" / 203mm	8" / 203mm	8" / 203mm	10" / 254mm
	Shoulder strap height (10° / 20° / 30°)	10.5-18" / 11.5-17" / 12.5-18" 267-406/ 292-432 / 318-457mm	13-19" / 14-20" / 15-21" 330-483 / 356-508 / 381-533mm	14-20" / 15-21" / 16-22" 356-508 / 381-533 / 406-559mm	16.5-24" / 17.5-25" / 18.5-26" 419-610 / 445-635 / 470-660mm
	Push handle adjustments	32-46" / 813-1168mm	34-47" / 864-1194mm	34-50" / 864-1270mm	35-51" / 889-1295mm
	Weight capacity regular/transit	75/66 lbs / 34/30kg	100/100 lbs / 45/45kg	170/170 lbs / 77/77kg	170/170 lbs / 77/77kg
	Weight of chair without front rigging	29 lbs / 34kg	30 lbs / 13.5kg	31 lbs / 14kg	32 lbs / 14.5kg
	Seat tilt angle and back recline				
	10° seat angle		100°, 105°, 110°, 115° recline options		
	20° seat angle		90°, 95°, 100°, 105° recline options		
	30° seat angle		80°, 85°, 90°, 95° recline options		

Product Overview: Adjustable Fixed-Tilt Coaster Scout

Attendant hand brake

One piece height adjustable push handle

Chair warning label

Never leave occupant unattended. Failure to read and follow user manual instructions could result in serious injury. To obtain a replacement user manual email sales.us@convaid.com or call 844-876-6245.

Transit anchors*
(Option)

Transit anchor logo sticker



12.5" Rear pneumatic knobby tires

8" x 2" Front ribbed tires



Packaging label
(reference)



Serial number label



ANVISA Label
(Brazil Only)

Height adjustable swing-away footplates



*Not shown - Headrest Extension, 3-pt belt, and torso harness required

Setting Up

Contents in the Box

List of items included in the box:

- Left and right footplates
- Accessories as ordered
- Coaster as ordered
- Allen key (5/32")
- User manual

Tools needed:

- Pliers
- 5/32" Allen Key
- 5 mm Allen Key
- 7/16" Wrench
- Phillips Screwdriver
- Ratchet with 3/4" socket

Preparing the Chair for Use

Once you have all components as ordered, the directions for use in this user manual will guide you through the process of preparing the chair for use:

Convaid recommends the initial fitting, adjustments, and setup take place with the help of your Convaid Representative and/or Convaid Service Dealer. However, if the instructions contained in this manual are followed carefully, a caregiver or attendant will be able to set up the chair.

Unfolding the Chair



1. Ensure chair is flat on the ground and unbuckle closure strap.



2. Press grey buttons on each side of Push Handle at the same time, and rotate Push Handle upward.



3. Grasp Push Handle with both hands and pull upward to unfold the Seatback.



4. Coaster Seatback and Base Frame can be unfolded in one motion. If two steps are used, push the Seatback forward to unfold the Base Frame.



5. Make sure Seatback and Base Frame lock into position with an audible click.



6. Press grey buttons on each side of Push Handle at the same time, and rotate Push Handle to desired height.



WARNING: Keep fingers away from the folding joints.

QR

Folding the Chair



1. Ensure wheel lock is engaged.



2. Ensure flip-up armrests are folded upward and locked (if applicable).

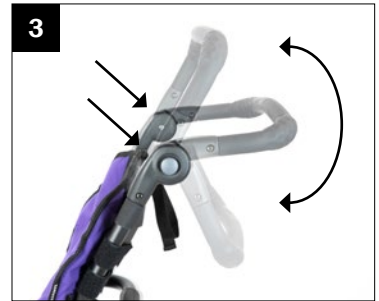

3. Press grey buttons on each side of Push Handle and rotate Push Handle down completely.



4. Unlock Seatback by pressing Seatback Trigger and push the Seatback forward.



5. Grasp each side of the frame and pull up on the Base Frame Trigger Lock and then pull back towards yourself to collapse the chair.



6. Buckle closure strap.

Note: Always properly secure the Coaster in a safe location when transporting Coaster as a cargo in vehicle

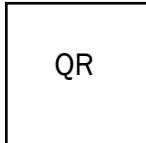

Lifting/Carrying the Chair



1. Ensure the Coaster is properly folded with the closure strap engaged.



2. The Coaster can be carried by the side Base Frame components.



3. The Coaster can also be carried by the seat bar located underneath the seat upholstery.

Note: To safely lift or carry the chair, always use both hands. Do not carry by upholstery or accessories.



WARNING: Always secure the chair with the closure strap when transporting the chair.

Fitting Guide

Correct seating and positioning encourages good posture, which in turn aids circulation, breathing and digestion. Please take the time to properly adjust the chair to fit the user. If the user is not correctly positioned, check the accessories section of this manual to see if one or more of our accessories would help to facilitate posture or consult a physical therapist. Improper seating can cause problems. Please consult a physical therapist or doctor for additional guidance.

Seat Back Height

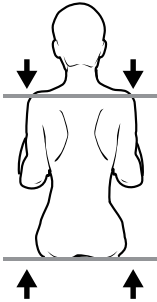

Seat back height varies according to chair type and seat width. Headrest extensions are available when extra height is needed to support the head. To determine the seat back height, measure the distance from the seat to the top of the shoulder or the upper part of the head, while seated.

Seat Width

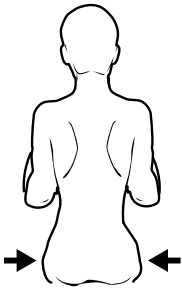

Proper seat width enables the user to sit comfortably and prevents problems from developing. While user is seated on a flat surface, measure the distance from hip to hip. The user should have enough room to prevent hips and thighs from rubbing against the frame. However, the chair should not be too wide or the user will slide around and posture could be affected. The seat width measurement for the Coaster is taken from the outside of the seat tubes.

Seat Depth



Seat Depth

Measure the distance from the most posterior portion of the buttocks to the back of the knee. Subtract from that measurement 1 - 2" to allow adequate clearance between the seat and the back of the knee.

Seat Depth Adjustment



1. To adjust seat depth, remove the screw from the front seat upholstery connecting it to the front riggings by using a Philips screw driver.



2. Remove the seat upholstery.



3. Undo Seat Extension Bolt and adjust the seat depth to desired position by maneuvering the front rigging or replacing the front rigging with a longer version.



4. Align the holes and reinstall bolt and nut into the seat tubes. Repeat steps 3-4 on opposite side.



5. Install Support Strap (if elongating the seat depth).
Note: Make sure rough, shiny side of strap is facing out.



6. Reinstall seat upholstery and re-attach the screws on both sides.

Standard Two-Piece Upholstery Position

Note: The lower seat upholstery is attached to the back upholstery with hook and loop. It is used to take up slack in the seat panel after seat depth adjustments have been made. It is not meant to create a downward slope of the seat upholstery.

Do not pull the seat upholstery hook and loop excessively to attach to the back upholstery.

Do loosely connect the seat upholstery hook and loop to the back upholstery once user is correctly positioned.

Excessive hook and loop overlap lifts seat fabric and pushes hips forward, creating poor posture and reducing effective seat depth.

Correct hook and loop adjustment provides room for hips, and makes greater use of seat depth.



Correct

Chair Set Up & Adjustment

Tilt and Recline

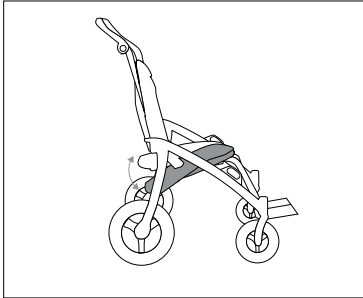

Tilt: Adjusting the tilt changes the seat angle. Adjusting the seat angle affects the recline angle.

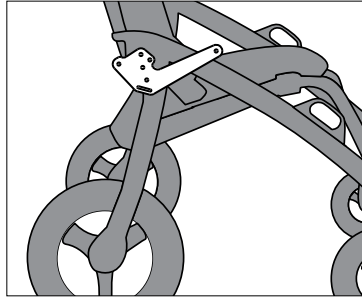

Tilt Plate Location: Underneath the upholstery on the rear of the seat.

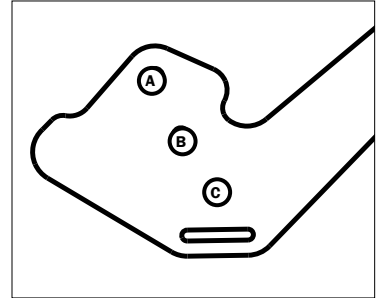

3. Tilt Angle Holes:

- A:** 10°
- B:** 20°
- C:** 30°

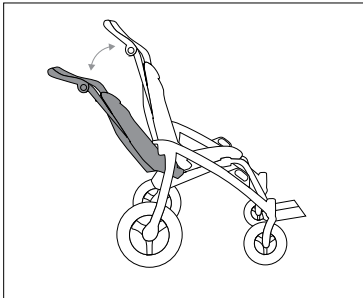

Recline: Adjusting the recline changes the seat back angle.

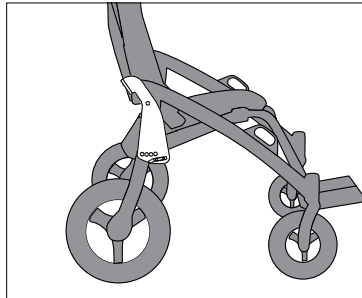

Recline Plate Location: Underneath the upholster on the bottom of the seat back.

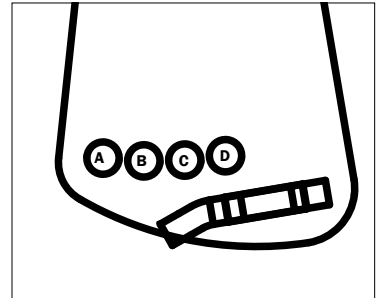

3. Recline Angle Holes:

The back recline angle is dependent on the seat angle.

- Tilt Angle 10°**
A: 115° **B:**110° **C:** 105° **D:**100°
- Tilt Angle 20°**
A: 105° **B:** 100° **C:** 95° **D:**90°
- Tilt Angle 30°**
A: 95° **B:** 90° **C:** 85° **D:**80°

Seat Angle (Tilt) Adjustment



1. Unhook the hook and loop overlap from the seat upholstery on to the back upholstery to fully expose the Tilt Plate on each side of the base frame.



2. Use a 5/32" Allen Key and pliers to remove the nut and bolt connecting the Tilt Plate from the Seat tubes.



3. Use the wrench to hold the nut while removing bolt. Be careful not to lose the spacer.



4. Relocate to desired seat angle position (see diagram in the Seat Set Up & Adjustment Section) and replace nut and bolt. Repeat on other side.



5. Reattach the seat upholstery hook and loop onto the back upholstery.



WARNING: Ensure the bolts are appropriately tightened and secure before using the Coaster.

Note: Adjusting the seat tilt angle may affect the seat back height and seat recline angle.

Seat Back Angle (Recline) Adjustment



1. Fold the back seat down by pressing the Seatback Trigger and pushing the Seatback forward.



2. Unhook the hook and loop overlap from the seat upholstery on to the back upholstery to fully expose the recline plate on each side of the base frame.



3. Use a 5/32" and a 5mm allen key to remove the bolt connecting the Recline Plate from the Side Pivot Bracket.



4. Relocate to desired position and replace bolt. See diagram in the Seat Set Up & Adjustment section, for appropriate seat back angle. Repeat steps 3 and 4 on other side.



5. Grasp Push Handle with both hands and pull upward to unfold the Seatback.



6. Reattach the seat upholstery hook and loop onto the back upholstery.



Warning: Ensure the bolts are appropriately tightened and secure before using the Coaster.

Note: Adjusting the seat back angle may impact the seat depth measurement.

Adjustable Tension Back



1. To adjust the Tension Back, unfasten the hook and loop straps and pull to desired position.



2. After adjustments are made, refasten hook and loop straps.



3. Repeat steps 1 and 2 on each set of straps.

Rear Anti-Tip Tubes and Curb Tipper



1. To install the anti-tip tube, align the tube with the end of the round frame tubing located next to the rear wheel.



2. Push the detent pin while positioning the anti-tip tube onto the round frame tubing, and push until the detent pin snaps through the hole located on the round frame tubing.



3. Repeat steps 1 & 2 for opposite side. To remove the Anti-Tip Tubes, perform above steps in reverse order.

Note: The Curb Tipper is installed the same way as the Rear Anti-tip tube. Make sure the Curb Tipper is angled up.



WARNING: If the user's weight is less than 50 lbs, the use of anti-tip tubes is recommended.



Castor Locks



1. To engage the castor lock press the button on the top of the castor lock mechanism.



2. To disengage the castor lock press the metal tab at the bottom of the castor lock mechanism.

Head Positioning Options

Headrest Extension



1. Insert Headrest Extension Tubes into the Headrest Holding Brackets and push down.

Occi Headwing



1. Attach the Occi Headwing at the desired height by inserting the strings through the grommet holes.



2. Secure head-wings by tying laces through the grommet holes.



3. Occi Headwing installed on seat.

Padded Headwings



1. Attach the padded head-wings at the desired height by wrapping the hook and loop straps around the back of the frame.



2. Secure headwings by tying laces through the grommet holes in the back of the seat upholstery or headrest extension.



3. Padded headwing installed on seat using both hook and loop straps and laces.

Trunk Positioning Options

H-Harness with Padded Covers

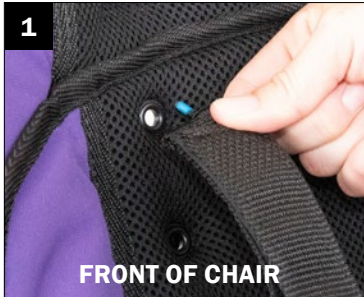

1. To attach the H-harness, insert the bolt at the end of the strap through the grommet hole in the back upholstery.



2. To adjust the H-harness height, unscrew the threaded knob on the back of the seat upholstery. Re-position the bolt at the end of the strap through the grommet hole in the back upholstery and re-secure the threaded knob.



3. H-harness installed on seat.

Note: Grommet choice should be level with or higher than the top of the shoulders. Choose a hole that will keep the user secure without the strap rubbing against the face or neck.

Full Torso Support Vest

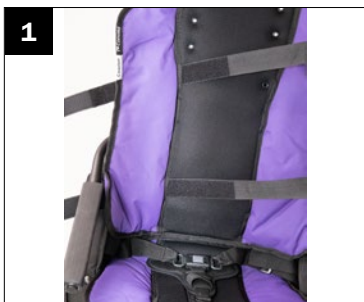

1. Attach the vest to the chair by wrapping the hook and loop straps around the seat back and securing tightly.

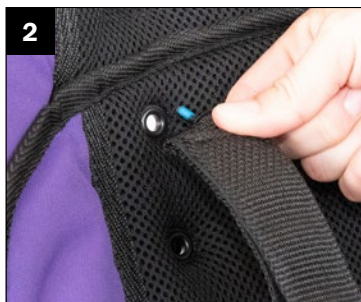

2. Screw the top of the shoulder straps into the back upholstery grommet holes using the hand knob and tighten .



3. Adjust side straps for proper fit.

Height and Tension Adjustable Back Positioner



1. Remove Hook and Loop cover.

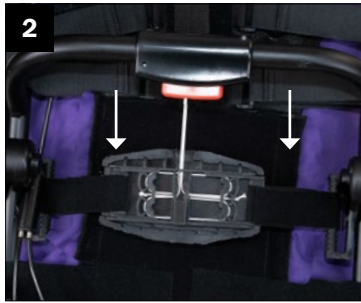

2. To adjust the height of the back positioner, loosen webbing on either side of the plastic back positioner.



3. If required for additional height adjustment, unscrew the bolt holding the back positioner hardware onto the frame.



4. Move the hardware to the desired height on the back frame, re-screw the bolts into position.

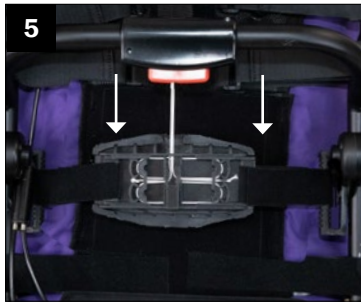

5. Tighten the webbing on either side of the plastic back positioner. When tightening the hook and loop pieces, ensure the moving components of the back positioner are touching in the center.



6. Adjust the tension towards the user's back by pulling upward on the tab and hook securely to the back of the tension adjustable back upholstery at the appropriate tension level.

Pelvic Positioning Options

Three-Point Positioning Belt

To adjust the belt to the desired tension, use the straps located laterally to the crotch belt on each side.



1. To attach or adjust the seat depth position of the crotch belt, use the strap below the crotch belt and thread through the desired plastic slit position.



2. To adjust the side tension of the belt, use the webbing and D-ring.



3. To engage the buckle, slide each of the side metal buckle components into the center buckle. If an H-harness is also being used, securely attach each harness J-hook to each metal buckle component.

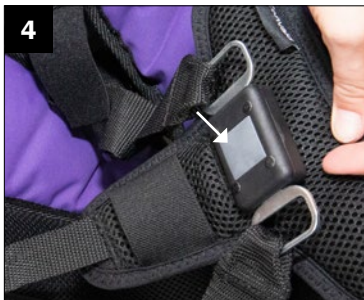

4. To unbuckle push the center of the buckle attached to the crotch strap, which joins the crotch strap to both belts.

Foot and Leg Positioning Options

Lateral Thigh Support (Adductor)



1. The adductor is attached with hook and loop straps on each side that fold and hook and loop underneath the seat.



2. Criss-cross the adductor flaps over the patient's thighs.



3. Wrap the straps around the sides of the back frame and attach with buckle.

Medial Thigh Support (Abductor)



1. The abductor is attached with hook and loop straps on each side that fold and hook and loop underneath the seat.

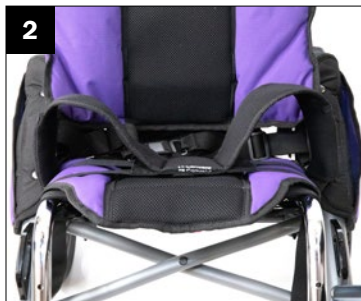

2. Wrap the abductor flaps over the user's thighs from the inside to the outside.



3. Strap the buckles around the side lower frame.

Foot Positioners

Foot Positioners may be crisscrossed over the foot to secure the whole foot or can be converted into simple ankle straps.



1. To attach foot positioner, thread strap through footplate.



2. The 2 buckles go in the front and the strap goes in the back.

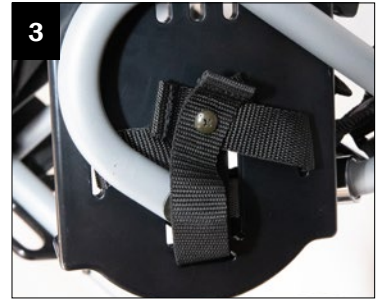

3. Bolt strap to underside of footplate using a phillips screwdriver.

Note: The same screw is used to install optional foot positioners and/or securement strap.

Footplate Securement Strap

The securement strap holds individual footplates together to prevent them from flipping up and down.



1. To secure the footplates, buckle the left and right strap together.

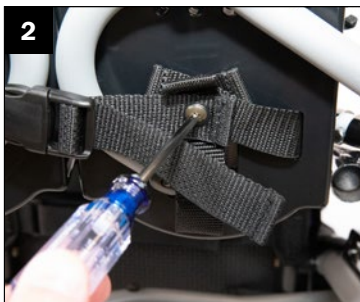

2. To remove the footplate securement strap, unscrew the screw on the bottom of the footplate using a screwdriver.

Footplate Height Adjustment

Seat-to-footplate height is measured from the back of the knee to the bottom of the heel. Feet or heels should rest comfortably on top of footplate.

All Convaid footplates are height adjustable. Footplates swing away for access or folding.



1. Pull on ring to remove detent pin holding footplate in place.

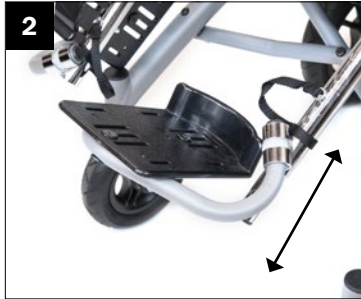

2. Move footplate up or down.



3. Realign holes and install detent pin through holes in tube.

Additional Footplate Height Adjustment

In the event that the footplate minimum height adjustment described above is inadequate, additional adjustments can be made.



1. Pull out detent pin.

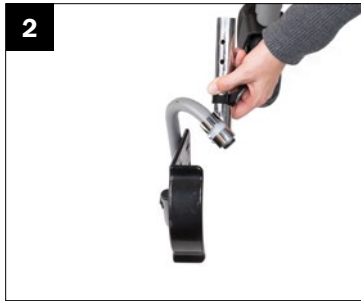

2. Remove the footplate extension tube from the front riggings.



3. Press the spring button.



4. Then pull the foot plate assembly bar apart from the extension tube housing.



5. Insert the footplate into the opposite end of the extension tube housing and allow the spring button to snap into place.



6. Return the footplate extension tube to the frame and secure with detent pin.



WARNING: Keep fingers away from adjustment holes

Footplate Depth Adjustment

All Coaster chairs offer adjustable footplate depth.

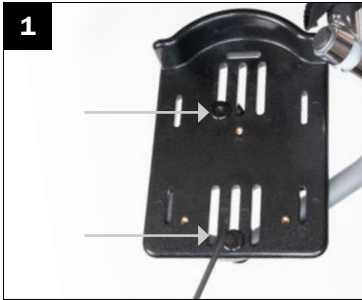

1. Use the 5/32" Allen key to loosen the two bolts located on the top of the footplate.



2. Slide footplate forward or rearward to desired depth.

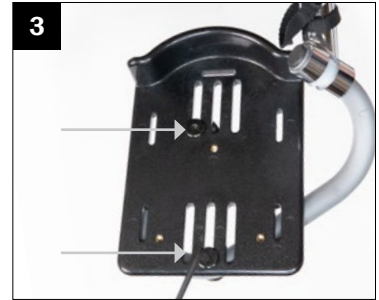

3. Retighten bolts.

Angle Adjustable Footplates

Angle adjustable footplates can be moved forward, sideways, and rotated vertically and horizontally.



1. To adjust the angle, remove the bolts using an Allen Key on the footplate and move to desired position.



2. Install and tighten the bolts using the 5/32" Allen key.

Additional One Piece Foot Plate Height Adjustment



1. To get more height adjustment from the one piece foot plate remove footplate from front riggings.

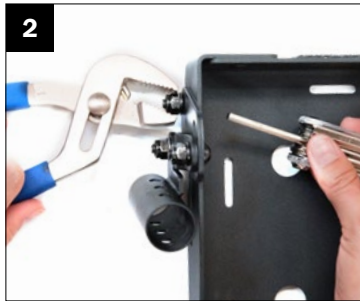

2. Remove the furthest posterior bolt and nut from each side of the one piece foot plate.

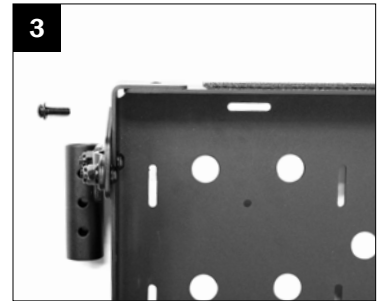

3. Flip the bolt and nut to the other side, making the bolt cap on the outside of the one piece foot plate.



4. Re-secure the bolt and nut into each side of the one piece foot plate.



5. Referencing Step #3, rotate each side foot plate tube downward until fully turned upside down. Reposition on front riggings and secure with detent pins.

Calf Panel



1. Lay Calf Panel flat and unfasten the hook and loop straps.



2. Attach hook and loop straps around front riggings.



3. Position Calf Panel across chair and attach hook and loop straps around opposite front rigging.

Side Panels



1. To remove the seat upholstery screw from the front riggings. (see instructions on seat depth change).



2. Install the side panels: remove the seat extension bolt and nut.



3. Secure the side panel with the bolt going through the grommet hole and reinstalling the bolt and nut into the seat extension tubes.



4. Secure the top using a philips head screw driver and screw into the top of the back frame. You may have to move a back strap to access the pre-drilled hole for this securement.



5. Use the hook and loop in the corner of the side panel to secure the bottom of the side panel to the back frame. Repeat steps 1-4 for the other side panel.



6. Side panel installed. To uninstall the side panel do these steps in reverse.

Note: As the tilt and recline is adjusted you may need to re-install the side panels to not limit the seat to back angle.

Fixed Front Riggings to Elevating Leg Rest Adjustment



1. Remove the upholstery using a philips screwdriver to gain access to the seat extension bolt and nut and the front riggings attachment.



2. To remove the fixed front riggings uninstall the seat extension bolt and nut using a 5/32" Allen key and pliers.



3. Remove the fixed front rigging from the seat tube.



4. Align the Elevating Leg Rest (ELR) front rigging with the plastic button facing outward and slide into the seat tube.



5. Reinstall the seat extension bolt and nut using a 5/32" Allen key and pliers, once the front rigging is installed to the appropriate seat depth.



6. Reinstall the upholstery, securing with the screw, using a philips screwdriver, through the seat upholstery strap into the front rigging tube. To switch between an ELR to a fixed front rigging, do steps 1-5 in the reverse order.

Coaster Scout Options

Attendant Hand Brake – Scout Only



1. To engage attendant hand brake, press lever in, towards the handle bar.



2. Push red lever up to lock the brake, push the black hand brake down to disengage the brake lock.

Scout Hand Brake Pad Adjustment



1. Turn the 5mm Allen key clockwise to move pad closer to disk (wheel should spin and not grab). This procedure can be performed with wheel installed.

Scout Hand Brake Brake Pad Wear

Brake pads should wear no thinner than .078”(2 mm) before replacement.

Scout Hand Brake Brake Pad Replacement



1. Loosen wheel with 5/8” wrench.

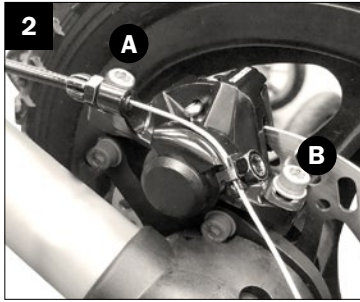

2. Remove calipers from the axle brackets by unscrewing Hex bolts (A) & (B) with a 5 mm Allen key.



3. Remove cotter pin with pliers.

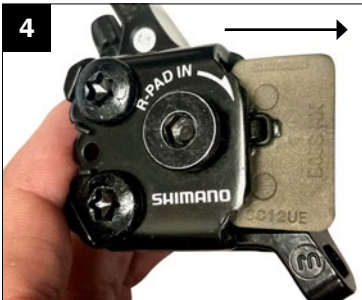

4. To remove pads, push pads through caliper.



5. Replace pads.



6. Reinsert pads into caliper. Follow steps 3-1 in reverse

Note: A brake system needs some time to break in. Initially, the rubbing of the pad on the disc may cause some noise.

Scout Brakes Tension Adjustment



1. Identify the attendant hand brake cable. This is only found on the Coaster Scout model.



2. Adjusting the tension on the screw piece at the end of the brake cable, may be enough adjustment by spinning the tension adjustment knob.



3. If more tension adjustment is required use an 5mm Allen key to loosen the bolt securing the brake cable to the disc brake. Re-secure the bolt once the optimal brake cable tension is found.



4. The brake cable properly tensioned will fully lock the wheels when the brake is engaged, but will allow proper rotation of the wheels when not engaged.

Wheels

Quick Release Rear Wheels



1. To remove, press down and hold the center wheel cap.



2. Grasp wheel and pull laterally.

Wheel Installation



1. Ensure wheel lock is not engaged.

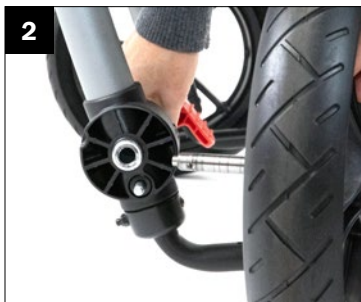

2. Ensure tire axle is free of debris before installing.

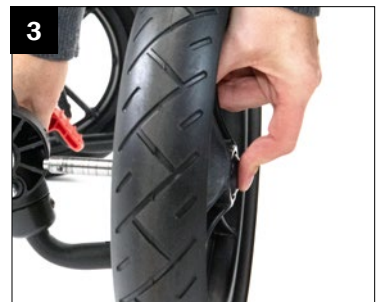

3. Press down and hold the center wheel cap.



4. Align axle to wheel lock bar.



5. Slide wheel axle into the wheel lock until it clicks into place.



WARNING: Ensure the wheels are installed properly. You will hear a “click” when wheel locks into place.

Loose Front Wheel Adjustment



1. If the front wheels become loose, remove Caster Stem Cap.

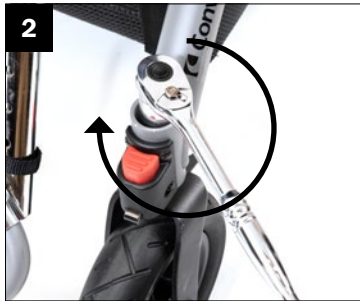

2. Use a ratchet with a 3/4" socket to tighten the stem nut. Adjust the stem nut clockwise until the stem nut is firmly tightened.



3. Replace Caster Stem Cap.

Locking and Unlocking Wheel Lock



WARNING: Proper care and maintenance must be taken to ensure proper function of the foot operated wheel locks.



WARNING: When operating the wheel lock, do not use excessive force to engage the locks with your foot. Only light pressure is needed to fully engage the locks.



WARNING: Teflon spray should be applied to wheel lock components weekly to ensure proper operations.



WARNING: Excessive force or poor maintenance will cause premature failure of the wheel locks.



1. To Unlock: Lift upward on wheel lock foot pad.



2. To Engage Lock: press downward on wheel lock foot pad.

Accessories

Headrest Cover (Canopy)



1. Align canopy retaining clips with upper tubing on back of the chair.



2. Push on clips with the palm of your hand until the canopy frame snaps into place.



3. To secure, route the hook and loop straps around each side frame and attach near push clips.



4. To open, grasp top of canopy and pull forward.



WARNING: To prevent breakage of canopy clips, always carefully follow the instructions and avoid twisting when attaching or removing the canopy.

Rain Cover



1. Take the top of the rain cover and wrap it around the top of the canopy.



2. Arrange the rain cover around the chair and pull the bottom of the rain cover to wrap around the footplate.



3. Find the two straps on the right and left side of the rain cover.



4. Secure rain cover to chair by wrapping the straps around each side of frame.



Note: For smaller size chairs, the straps may connect to each other behind the chair for a tighter fit.

Mosquito Net Cover



1. Take the top of the mosquito net and wrap it around the top of the canopy. The top is identifiable by having two black ties.



2. Arrange the mosquito net around the wheelchair and pull the bottom of the mosquito net to wrap around the footplate.



3. Find the two hook and loop straps on the right and left side of the mosquito net.



4. Secure mosquito net to wheelchair by wrapping hook and loop straps around each side of wheelchair frame.



Note: For smaller size chairs, the hook and loop straps may connect to each other behind the chair for a tighter fit.

Height Adjustable Locking Armrest



1. To unlock the armrest from the down or flipped-up position, press the button on the inside of the frame attachment.



2. To adjust the height of the armrest, use a 5/32" Allen key to move the placement of the bolt and armrest hardware up and down on the back frame tubes.

Upper Extremity Support Surface (Tray)



1. Pull out Tray Extension Tubes on each side of the Armrest by pressing detent pin on the underside of each armrest.



2. Extend the tray extension tubes and ensure the detent pins snap into place with them extended, securing the location.



3. With tray locks in the up position, align Tray Bracket to Tray Extension Tubes and slide tray to desired position.

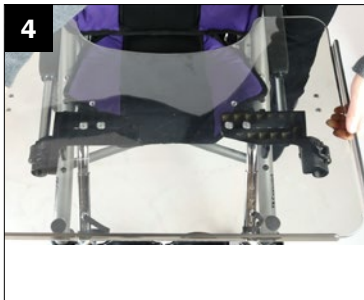

4. Slide tray to desired position.



5. Engage Tray Locks on each side of the Tray Brackets, by flipping the tray lock into the down position.



6. To adjust the height: Use 5/32" Allen Key to loosen the bolt on each side of the tray hardware.



4. Slide the tray hardware to the desired height.



5. Retighten the tray hardware height.

Saddle Bags

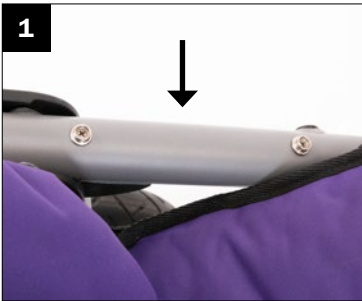

1. Insert the saddle bag hook and loop strap around the side frame tube, between the two snap buttons.



2. Snap the two push buttons into place on the two meeting buttons on the side frame.



3. Wrap rear hook and loop strap around Seat Tube and secure.

Under Seat Storage Basket / Medical Necessity Basket



1. Connect front hook and loop straps by looping them over the front x brace of the frame.



2. Loop hook and loop strap through the thin rectangular opening at the bottom of the tilt plate and secure. Repeat for opposite side.



3. Under seat storage basket installed.

Note: Do not exceed under seat storage basket weight capacity of 25 lbs. The Medical Necessity Basket can withstand a weight capacity of 50 lbs.

Utility Bag



1. To attach Utility Bag use the hooks from the utility bag and the straps on the back of the back upholstery.



2. Utility Bag can be removed and converted to a tote bag.



WARNING: Do not overload bag due to potential of chair tipping when empty.

Maintenance, Operating & Safety Instructions

- READ ALL INSTRUCTIONS BEFORE USING THE PRODUCT
- ALWAYS FOLLOW THESE SAFETY INSTRUCTIONS
- SAVE SAFETY INSTRUCTIONS FOR FUTURE REFERENCE



WARNING:

- For safety reasons, the Coaster belt should be used at all times.
- Do not leave user unattended.
- Do not strap user too tight.
- Straps should not interfere with breathing or circulation.
- Always apply wheel locks before letting go of the chair.
- If front edge of seat is at or forward of the point where tires touch the floor, avoid using front of seat tubes for support during entry or exit from chair to prevent tipping.
- Avoid using footplates for weight support during exit or entry of the chair.

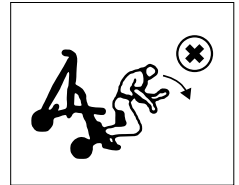

Waste Disposal

The shipping carton should be kept for possible return to the manufacturer/service facility for repair or maintenance. Other paper packaging waste should be set aside for recycling. For disposition of replaced parts or the complete chair, the materials should be separated into: plastic, rubber, steel, aluminum, etc., and set aside for recycling.

Spare Parts

If you need any spare parts for your chair, please visit or call Convaid or your Service Dealer. If the part is not under warranty, you will receive an estimate of the cost and, if necessary, shipping instructions for the return of the chair for repairs.

Chair Maintenance

The following maintenance procedures should be conducted on a regular basis: Examine your Convoid product visually from time to time for possible wear and tear. Lubricant should be applied to frame and moving parts to maintain easy folding and adjustment.

- a) **Tire Air Pressure:** The air pressure in your pneumatic tires should be checked WEEKLY, since low air pressure may affect brake ability. The recommended air pressure is located on the side of the tire wall.
- b) **Axles and Moving Parts:** Axles and moving parts should be wiped off WEEKLY with a slightly moist cloth, to remove dust, dirt and mud. Sparingly apply a high quality Teflon spray* after each cleaning. DO NOT USE WD-40, silicone sprays or other lubricant sprays as they will attract dust and dirt.
- c) **Repair or replace** loose, worn, bent, missing or damaged parts before using the chair.
- d) **Flat tire:** In the event of flat tire, please contact customer service or local dealer for specific repair or replacement instructions.
 * Use a non-toxic, hypoallergenic, dry lubricant for all moving parts of the frame.

Maintenance Chart	Weekly	Every 3 months	Every 6 months	As necessary
Rims and tires	•			
Wheel lock and hand brakes	•			
Accessories	•			
Front and rear wheel axles	•			
Cleaning & lubricating all moving parts*°	•			
Belts, zippers and hook and loop closures		•		
Seat/back upholstery**/tautness		•		
Armrests & foam (cushioned parts)			•	
Frame			•	
Contacting a Convoid Dealer for service or repair***				•

* Use a non-toxic, hypoallergenic, dry lubricant for all moving parts of the frame.

** Follow cleaning instructions for appropriate user hygiene.

*** **NOTE:** Repair or replacement of non-removable, worn or broken parts must be performed by a qualified service facility.

° **NOTE:** Do NOT use WD-40 or other silicone based spray as a lubricant.

Cleaning

Cleaning and disinfection

To prevent the spread of germs, clean all skin contacting areas with disinfectant wipes regularly. Keep frame dry and apply a non-toxic, hypoallergenic and biodegradable lubricant to all moving parts. After longer storage periods, and before further use, the entire chair needs to be serviced, cleaned, and disinfected.

Cleaning of frame

Frame is to be kept dry and free of dirt and should be wiped off with a non-toxic, hypoallergenic and biodegradable wipe. Lubricant should be applied to moving parts as needed to maintain easy folding and adjustment.

Cleaning of wheels and brakes

Wheels and brakes should be kept free of dirt or mud after each use. Foreign objects could cause interference with moving parts. Wipe wheels and brakes with a moist cloth as needed and readjust brakes if needed.

Cleaning of Scout Tires

To avoid damage to the brake seals, use only alcohol or water when cleaning the caliper part.

Cleaning of fabric cover

Seat and back upholstery can be easily removed, washed, air dried and reattached to the chair. Use standard detergent to wash fabric.

Cushioned parts can also be removed from chair, washed or wiped off with a moist cloth. Before reattaching them to the chair, make sure they are completely dry. Use mild detergent to wash fabric. Use gentle cycle and cold water. Hang dry.



Storage

Store your chair in a clean, dry area and avoid extended exposure to heat or moisture. After extended storage periods, and before reuse, the entire chair needs to be serviced, cleaned and disinfected.

Repairs

User: The user can replace easily removable parts or accessories, e.g. foot supports, heel loops, all fabric items, hand grips, etc.

Manufacturer/Service Facility: Repair or replacement of permanently attached, worn or broken parts must be performed by a qualified service facility. Any individual part of the chair can be replaced. Contact the manufacturer/service facility for needed repairs. The chair should be packaged in the original or suitable shipping carton for return to the manufacturer/service facility.

Safety Instructions

- Do not attempt to take occupied chair up or down stairs, escalators, steep inclines, icy or slippery surfaces.
- To avoid tipping, do not overload the chair, or hang heavy items on the handles that might cause tipping.
- Frequently inspect the adjustments on the frame and the positioning accessories.
- Do not use chair after occupant has outgrown it.
- Do not ignore minor malfunctions and maintain the chair in good operating condition.
- Inspect the wheel locks and brakes, if applicable, regularly and adjust as needed.
- If and whenever possible and feasible, the rider should transfer out of the chair and into an approved vehicle seat and/or passenger restraint system. However, if a transfer is not possible, use only designated chairs in a moving vehicle which contain the Wheelchair Tie-down and Occupant Restraint System (WTORS) following the requirements of SAE J2249. Follow tie-down harness manufacturer's instructions carefully and refer to Transit Section for specifics.
- When going up a curb or step, face forward and tilt the chair back to lift the front wheels over the curb. Move forward and lift the rear wheels over the curb.
- When going down a curb, approach the curb backwards. Lower the rear wheels down the curb and continue backwards, taking the weight off the front wheels so they can be gently lowered.
- Maintain control of the chair at all times while going up/down ramp. Avoid steep slopes, particularly with a heavy occupant. If in doubt, do not proceed unless a third party is present to help maintain control of chair.
- When transferring user to or from chair, apply foot wheel locks.

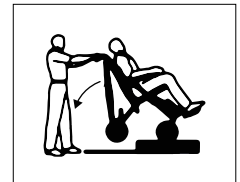
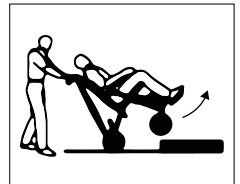
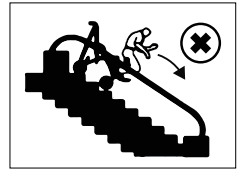

Upholstery Removal



1. To remove the seat upholstery, remove hook and loop connecting the seat upholstery to the bottom of the back upholstery.



2. Remove the hook and loop straps underneath the seat upholstery.



3. Remove the screws using a Phillips screwdriver, which attach the seat upholstery to the front riggings.



4. Remove the hook and loop from the seat upholstery and the bottom mesh and take off the seat upholstery.



5. To remove the back upholstery, remove the hook and loop straps that attach the back upholstery to the frame, and take off upholstery.

Transport, Storage and Disposal

Recommended Clear Zones In Vehicle

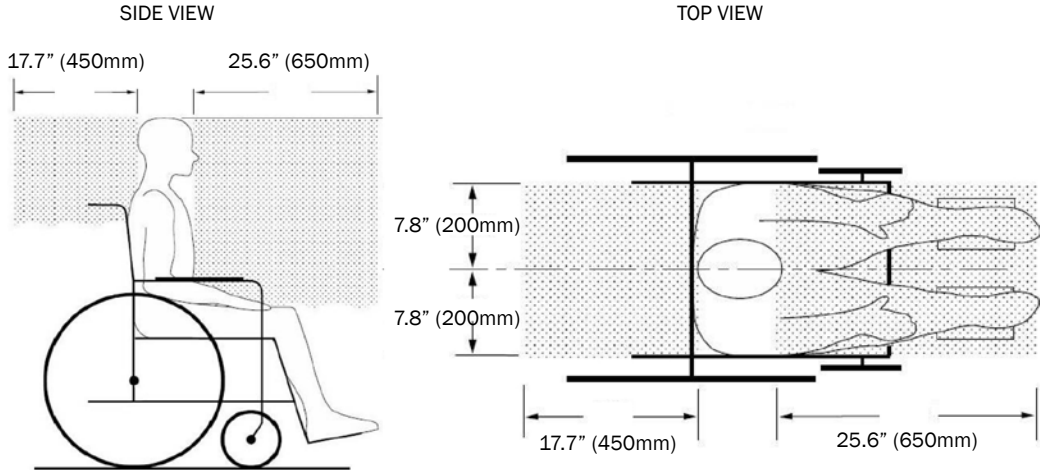

The rear clear zone is measured from the rearmost point on an occupant's head. The front clear zone is measured from the frontmost point on an occupant's head.

Providing Clear Space & Padding

Position the chair aboard the motor vehicle to ensure sufficient clear space in front of, and behind, the occupant.



CAUTION: If there are any hard or sharp objects or components near the chair, such as components of lifts or fold-up seats, they must be covered with heavy-duty energy-absorbing padding to ensure the safety of the chair occupant and other passengers.

Securing the Chair for Transport



1. Inspect all tie-down straps for signs of wear to the webbing and replace any straps that are worn. If there is any wear do not use those tie downs and instead use new tie down straps.

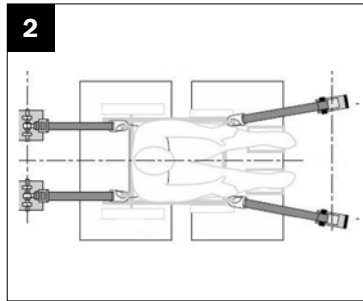

2. Position the chair between the front and rear tiedown anchor points, allowing for the correct angle of adjustment of the tiedown straps.

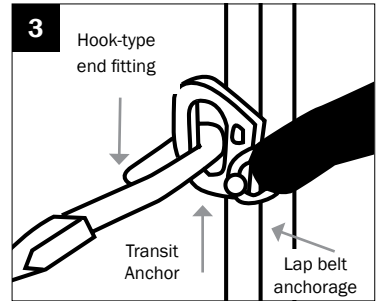

3. Attach tiedown straps to the 4 securement points (hook brackets) located on the chair's legs in accordance with the WTORS manufacturer's instructions.

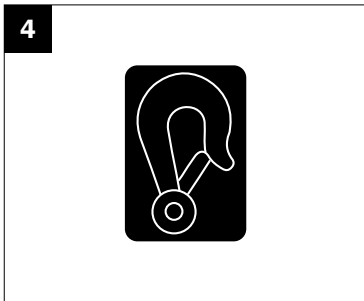

4. Securement points are identified by the symbol.



5. Securement point's location on the wheelchair.

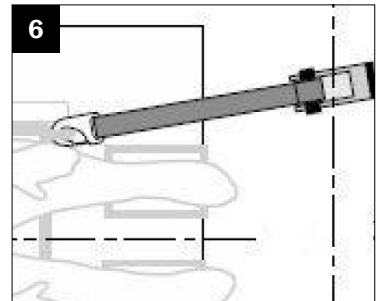

6. Tighten the straps to remove any excess slack and provide tension between the front and rear tie-down strap.

When securing the occupied Coaster, it is important that the WTORS anchor points on the floor and wall of the motor vehicle are positioned properly according to the WTORS manufacturer's instructions. The chair must be positioned facing forward inside the vehicle.

The floor anchor points and chair should meet the following:

- Be located so that the tie-down straps follow a straight, clear path from the chair securement points to the floor anchor points and
- Be located so that the front straps are angled outward from the sides of the chair

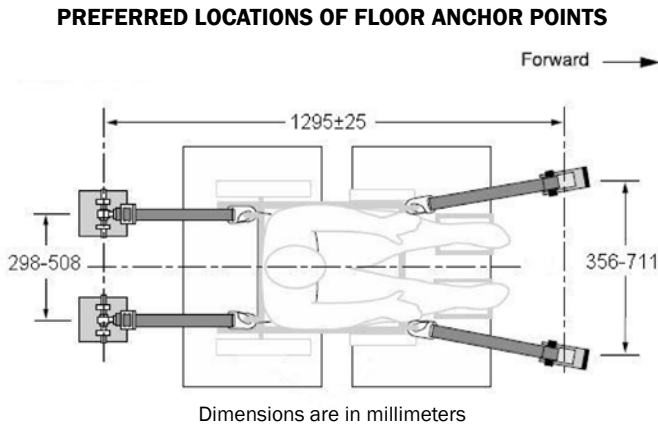

- Be located so that the rear straps are anchored straight back from the chair securement points

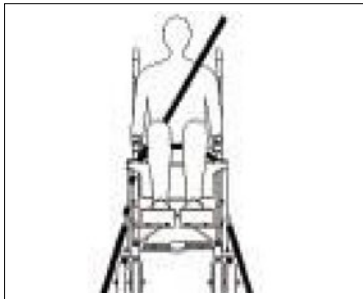

Front tiedown straps angled away from sides of chair.



Correct positions of shoulder and lap belt restraints and wheelchair tie-downs.

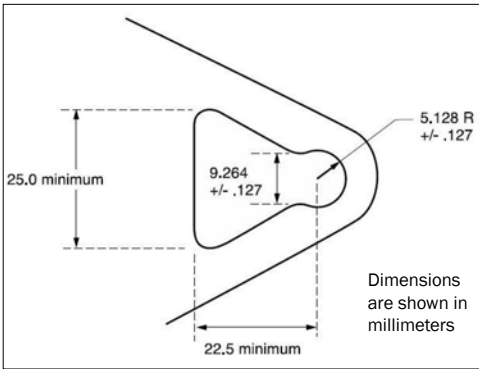

Standard metal clip at lower end of shoulder belt and at end of optional chair-anchored lap belt.

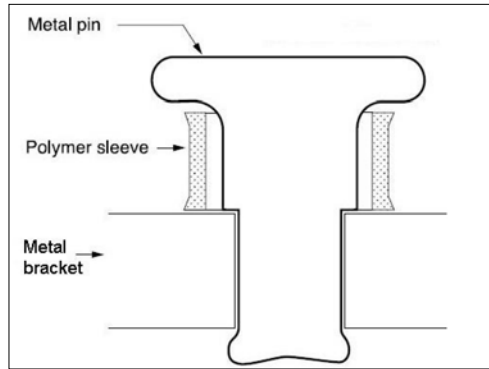

Pin/Bushing on lap belt or on chair securement point brackets that the standard metal clip connects to.

Restraining the Chair Occupant

Your Convoid transit chair was dynamically crash tested in a forward-facing configuration using an appropriately sized crash-test dummy restrained by both upper-torso (shoulder) and lower-torso (lap) belts. To reduce the possibility of head and chest injuries resulting from contact with vehicle components, you must use both upper and lower torso belts.

Your Convoid transit chair provides for the use of an optional chair-anchored lap belt. The optional belt, which has been dynamically tested in accordance with WC19/7176-19, may be ordered from Convoid at a nominal additional cost. To attach the lap belt to the chair, secure the metal clips at the ends of the lap belt, to the pin/bushing connectors located on the chair's rear securement-point brackets.

Before loading the chair onto the vehicle lift, fasten the lap belt over the chair user's pelvis. The chair user should wear the optional lap belt as low over the pelvis and as snugly as possible without compromising comfort. The vehicle-anchored shoulder belt may then be clipped to the pin/ bushing connector located on the lap belt near where it attaches to the chair. When not in use, the optional lap belt may be looped underneath the seat, buckled, and tightened.

If the chair is purchased without the optional lap belt or if the chair user elects not to use the belt, a vehicle-anchored lap and shoulder belt must be used. As with the chair-anchored lap belt, it is very important to position the vehicle-anchored lap belt low over the pelvis so that the angle of the lap belt is within the preferred zone of 45° to 75° to the horizontal or the optional zone of 30° to 45° to the horizontal.

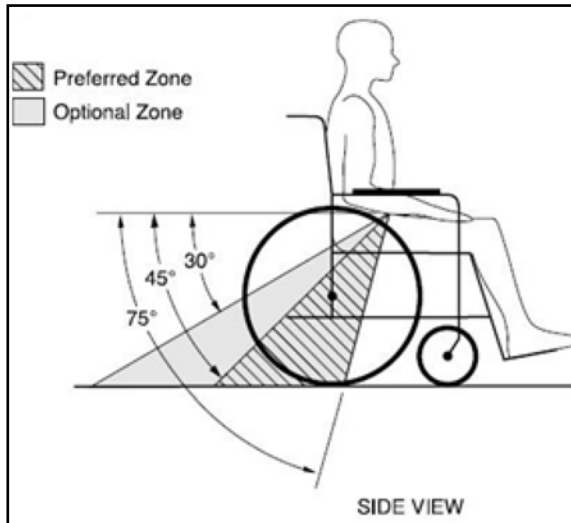

Note: Steeper side view pelvic-belt angles are especially important if the pelvic belt is intended to be used for postural support in addition to occupant restraint in a frontal crash. Steeper angles will reduce the tendency for a vertical gap to develop between the user and the belt due to compliance of seat cushions and belt movement, thereby reducing the tendency for the user to slip under the belt for the belt to ride up on the soft abdomen during normal use.

Note: Steeper belt angles also reduce the tendency for upper-torso belts to pull the pelvic belt onto the abdomen during frontal impact loading.

Be sure that the shoulder belt crosses the chest and the middle of one shoulder and that belt restraints are not held a way from the body by chair components or parts, such as arm rests or chair legs.

Thread the lap belt under the frame tubes located directly under the user’s elbows and pull the belt snug against the pelvis. Ensure that belt webbing is not twisted and remains in contact with the chair user’s shoulder and chest as this may compromise safety.

Using Postural Belts & Supports

Positioning accessories such as pelvic positioning belts, anterior trunk supports, and lateral trunk supports may be used while in transit but are not designed to provide restraint during a crash.

Postural supports and belts should not be relied on for restraint in a vehicle crash and should be used only in conjunction with lap and shoulder belts that have been designed for restraint in a motor vehicle and crash tested in accordance with RESNA WC-4-19 and/or ISO 7176-19.

Trays & Other Chair Components

To reduce the risk of potential injury to the chair user or other occupants in a motor-vehicle crash, chair-mounted accessories, such as trays and respiratory equipment, must be removed and secured separately during transit. Use tether straps or other strong attachment hardware to prevent items from breaking loose and causing injury during a crash.

WTORS Manufacturers

Convaid is a wheelchair manufacturer and does not offer wheelchair tie-down and occupant restraint systems (WTORS). However, products that comply with current WTORS standards can be obtained from the following companies that specialize in crash-tested WTORS:

Ortho Safe Systems

P.O. Box 9435
Trenton, NJ 08650 U.S.A
(609) 587-9444

Sure-Lok

400 S. Greenwood Ave. #302
Easton, PA 18045
U.S.A (866) 787-3565

Q'Straint

5553 Ravenswood Rd. #110
Ft. Lauderdale, FL
33312 U.S.A
(954) 986-9987

Unwin Safety Systems

Unwin House
The Horseshoe Coat Road,
Martock, TA12, 6EY U.K.
(44) (01935) 827740

Storage

Store your chair in a clean, dry area and avoid extended exposure to heat or moisture. After extended storage periods, and before reuse, the entire chair needs to be serviced, cleaned and disinfected.

Repairs

User: The user can replace easily removable parts or accessories, e.g. foot supports, heel loops, all fabric items, hand grips, etc.

Manufacturer/Service Facility: Repair or replacement of permanently attached, worn or broken parts must be performed by a qualified service facility. Any individual part of the chair can be replaced. Contact the manufacturer/service facility for needed repairs. The chair should be packaged in the original or suitable shipping carton for return to the manufacturer/service facility.

Authorized Service Dealer

Please record the Convaid Dealer from which you purchased your chair:

Company: _____

Address: _____

Phone: _____ Website: _____

Contact: _____ Email: _____

Serial #: _____

Declaration of Conformity

This product conforms to the requirements of the Medical Devices Regulation (2017/745).

The CE mark must be removed when:

- Rebuilding the product
- Using the product outside the intended purpose and declaration of conformity
- Using other than original Convaid spare parts and fittings

When combining the device with other products, the combination must not change the intended purpose of the products or modify the products in such a way that compliance with the applicable requirements may be affected. The person / company responsible for the combination of the products must ensure that the applicable requirements are fulfilled.



Warranty

Convoid warrants to the original retail purchaser of the Convoid product, that if any part thereof proves functionally defective in material or workmanship within the specified warranty period, such defective part will be repaired or replaced (at Convoid’s discretion) free of charge. Warranty service may be performed by Convoid service center or (at Convoid’s discretion) the factory.

Warranty Period

- Mobility base.....Five years
- Other components.....One year
- Fabric & webbing.....One year

This warranty does not cover normal wear and tear or damage caused by accident or misuse. To exercise this limited warranty, the user should first obtain a Return Authorization Number from Convoid’s customer service. The product must be delivered charges pre-paid to the factory or to an authorized service center, together with a copy of the original invoice, the Return Authorization Number and a written description of the problem.

THIS LIMITED WARRANTY EXCLUDES ANY CLAIM FOR INCIDENTAL OR CONSEQUENTIAL DAMAGES. ANY IMPLIED WARRANTY APPLICABLE IS LIMITED TO THE DURATION OF THIS WRITTEN WARRANTY. SOME STATES DO NOT ALLOW THE EXCLUSION OR LIMITATIONS OF INCIDENTAL OR CONSEQUENTIAL DAMAGES OR LIMITATIONS ON HOW LONG AN IMPLIED WARRANTY LASTS, SO THE ABOVE LIMITATIONS OR EXCLUSIONS MAY NOT APPLY TO THE USER. THERE ARE NO WARRANTIES WHICH EXTEND BEYOND THE DESCRIPTION ON THE FACE THEREOF. This warranty gives the user specific legal rights and the user may have other rights that vary from state to state. Warranty applicable in USA only, may vary in other countries.

UK REP

Etac Ltd.

Unit 60, Hartlebury Trading Estate,
Hartlebury, Kidderminster,
Worcestershire, DY10 4JB
+44 121 561 2222

EU REP

R82 A/S

Parallevej 3
DK-8751 Gedved
+45 796 858 88



Convoid Products, LLC

2830 California Street
Torrance, CA 90503, USA



+1 (844) US-Mobility



convoidsales.us@etac.com



Fax: +1 (310) 618-8811



International +1 (844) 876-6245



international.convoid.us@etac.com



www.etac.com

 **Convoid**
by Etac